

2018 APBA THUNDERCAT RACING RULES **NEW FOR 2018 SEASON 2/17/18**

The mission of the APBA Thundercat Category is to promote safe, affordable, fun racing with close competition for the enjoyment of racers and fans. Thundercats are PVC/rubber tunnel boats, powered by readily available basic Stock Outboard engines. The entry-level Bandit Class, Outlaw Class, and the Experimental (X) Class, offer two-person team competition with simplified rules and inspection requirements. Accessible, fair racing gives all drivers and co-drivers an equal chance of winning.

While it is not possible to provide for every possible situation, the following rules are the basic guidelines for Thundercat racing. Any dispute will be settled by the race committee and/or the Superlight Racing Commission. The minimum penalty is disqualification for the heat/day. Therefore, before you make any "marginal" alteration, get a ruling from the APBA Thundercat Racing Commission Chairman.

10.000 GENERAL

APBA General Racing Rules take precedence over those written by any category. Categories, when writing rules regarding a subject covered by General Racing Rules, may only add more restrictive details. These more restrictive rules will then prevail for that category.

10.002 APBA Racing License is required for an owner, driver and co-driver. The license fee will be set annually by APBA. Members who join between October 1 and 31 shall be given a 13-month membership. Single event memberships are allowed.

10.003 Boat Registration Fee For each competing boat bearing a racing number there shall be an annual registration fee (payable to APBA) to be put into a promotional fund and administered by the Superlight Chairman.

10.004 Rookies A novice driver (an APBA member in good standing who has never driven a registered APBA Thundercat in closed course competition in a sanctioned race) shall for six events tape or paint a 2-inch wide white cross on his helmet, extending from the front over the top of the helmet to the back rim, and from left ear over the top of the helmet to the right ear. The new driver shall be given an oral examination by the referee, and shall show knowledge of course racing rules before being approved to enter a race. Any new driver's first day of participation in Thundercat competition shall consist of at least one heat of racing during a sanctioned closed course event. The new driver shall drive at the back of the pack. His/her starting position will be the furthest to the first turn. He/she will take all turns to the outside, yielding right of way to all other competitors, while being observed by the referee and course officials. If he/she is not cleared for "open competition" at the end of the heat, he/she shall run additional heats in the same manner until the referee clears the driver for open competition.

10.005 Dress Code The Thundercat Commission recommends that drivers wear a minimum uniform consisting of a collared shirt with racing identification. At a Championship or sponsored event, drivers and crew must wear uniforms consisting of pants and shirt with racing identification. Such a requirement must appear on the race circular.

20.000 SAFETY

20.001 Helmets and Life Jackets: A driver (and passenger, if any) when operating registered equipment at any time while at a sanctioned regatta, must wear complete safety equipment, including helmet and life jacket, except where exempt, with the following exception: Helmets may be removed only (1) when the boat is stopped or operated off-plane at idle speed, and (2) when there are no other race boats operating on plane on the race course or in the vicinity so as to create a danger, or (3) when the driver's boat is tethered to a tow boat. The helmet only may be removed by drivers of stalled boats during point-to-point marathons.

Considering the fact that there is no safest life jacket and helmet that will eliminate all risks, the participants are solely and ultimately responsible for selecting a suitable helmet and life jacket. Only those considered in good condition may be used.

A. Helmets shall meet minimum rating specifications (SNELL 2005, SFI, FIA or newer) per list on document "APBA Driver Helmets Accepted for Competition and Vintage." Document location: APBA Resources webpage.

- 1) The upper fifty percent (50%) of the helmet must be a single color of the following: yellow or fluorescent (high visibility) yellow or lime green or orange or international orange or fluorescent red. Competitors may put writing or artwork in an area across the front to the helmet directly above the opening. This area is not to exceed 8" wide x 2" high.
- 2) Half-shell and 3/4 type helmets are not allowed.
- 3) No image recording devices may be attached to helmets.

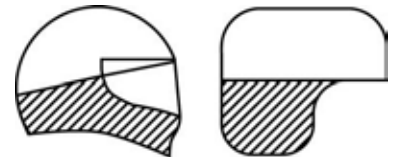

- a) Empirical data is showing that when the camera does not disengage immediately upon water impact it can lead to a neck injury. The camera acts as a keel and creates drag using the neck as the fulcrum.

20.002 Life jackets: All racing life jackets must be constructed in compliance with the "APBA Life Jacket Basic Manufacturing Specifications" dated March 1, 2013. Copies are available from APBA National Headquarters. (See 170.015 for P-750 Class additional specifications.)

- 1) All racing life jackets must have a permanent affixed (sewn in) manufacturer's label indicating:
 - a) The date of manufacture or the date of recertification.
 - b) The manufacturer's or recertifier's company name.
 - c) The type category (A, A-100, B or C)
 - "A" For use in an open cockpit and by an unrestrained occupant. Maximum boat speed is less than 100 mph.
 - "A-100" For use in an open cockpit and by an unrestrained occupant. Maximum boat speed is 100 mph or greater. A-100 may also be used where A is required.
 - "B" For use by a restrained occupant of a cockpit, not necessarily employing supplemental life support equipment needing life jacket accommodations.
 - "C" For use by a restrained occupant of a cockpit, that employs supplemental life support equipment.
 - d) Color Requirements: All life jackets shall have at least 70% of the upper surfaces above the waist, both front and back, international orange or yellow in color.
 - f) Every driver shall demonstrate that his life jacket will function properly when requested by the referee.

20.003 Cut-Resistant Pants And Sleeves Drivers and co-drivers shall wear cut-resistant ankle length pants and full length cut-resistant sleeves while racing or testing at an APBA sanctioned event. All limbs must be covered at all times including feet. Gloves optional.

20.004 Physical Exam On race morning, physical examinations of drivers and co-drivers for current physical and cognitive function may be conducted according to guidelines established by the race committee.

20.005 Propellers Shall Be Off Or Covered on trailered boats to minimize injury to crew or viewing public.

20.006 Starting Motor On Land (not in the water): Propellers, nuts, washers, and locking devices shall be removed. Anyone violating this rule will be disqualified for 30 days and fined \$30.00 payable to APBA.

20.007 One Fire Extinguisher shall be readily available on or near each trailer.

20.008 Physical Exam On race morning, physical examinations of drivers and co-drivers for current physical and cognitive function may be conducted according to guidelines established by the race committee.

20.009 Cut-Resistant Pants And Sleeves Drivers and co-drivers shall wear cut-resistant ankle length pants and full length cut-resistant sleeves while racing or testing at an APBA sanctioned event.

20.010 Propellers Shall Be Off Or Covered on trailered boats to minimize injury to crew or viewing public.

20.011 Starting Motor On Land (not in the water): Propellers, nuts, washers, and locking devices shall be removed. Anyone violating this rule will be disqualified for 30 days and fined \$30.00 payable to APBA.

20.012 One Fire Extinguisher shall be readily available on or near each trailer.

30.000 CLASSES

30.001 All Thundercat Classes shall be offered at all Thundercat events. All classes shall not necessarily be offered prize money or trophies. Classes may be run together but shall be scored separately. If the prize purse is evenly distributed among all competitors, all classes shall be included.

30.002 Two Person Team Each Thundercat team shall comprise a specifically designated driver and co-driver.

30.003 Outlaw and X-Class Drivers must be at least seventeen (17) years of age to compete.

30.004 Bandit Drivers must be at least sixteen (16) years of age to compete.

30.005 Bandit, Outlaw and X-Class Co-Drivers must be at least fourteen (14) years of age to compete.

30.007 "Bandit" Class Approved engines:

Nissan/Tohatsu 50HP; must be stock configuration	Mercury 40 HP four-stroke
Nissan/Tohatsu 40HP with 50 tuner pipe and 50 carbs only.	Mercury 40 HP four-stroke
OMC 40 HP	Mercury 40 HP short shaft two-stroke
Yamaha 40 HP (6H4)	Mercury 50HP (44 c.i.d.)

E-Tec 40 HP or 50 HP two-stroke (provisional motor for **2018) Tohatsu 50 TLDI (provisional motor for 2018)**)

30.008 "Outlaw" Class Approved engines:

Mercury 40 HP 2 stroke (may change carbs to 60 HP carbs & follow 60 rules.)	Mercury / Mariner/ Sea-Pro 50/55/60 HP (EO) 51.8 c.i.d.
	Mercury / Mariner 60 HP (59.1 c.i.d)
Nissan / Tohatsu 40/50 HP (50d) (40d)	Mercury 60 HP four-stroke with no minimum weight
Johnson / Evinrude 40/50 HP (DP-39m)	E-Tec 60 HP two-stroke
Yamaha 40/50 HP (6H5) (6H4)	

30.009 Experimental Class (X-Class) is for those that do not comply with the Superlight Tunnel Engine Technical Rules. This class shall be entitled to High Point Championship. Engines shall not exceed 1000 cc's and tiller arm, and use pump gas only. Rules that apply are 50.004, 50.005, 50.010, 50.011, 50.015, 50.016 and all APBA General Safety and General Racing Rules. All hull rules apply.

30.010 P750 Class (see Rule 170.000)

40.000 HULL

40.001 Boats: Manufacturers or importers must submit the homologation application for their boats to the Thundercat Chairman before the 31st of March. They shall furnish valid, audited proof that 2 (two) boats have been manufactured and advertised, and are commercially available in the open market 60 days from the date of order. Below the waterline features must be included in the homologation applications. Make, model, and year shall be permanently marked on the boats. All boats must meet specifications as submitted, and must have minimum dimensions of 12' 6" in length and 5' 6" in width. No fiberglass reinforcements are allowed on boats newer than 1997. Boats built in 1997 and earlier will be grandfathered with hard bottom, and must have proof of manufacture date. There is no homologation on new boats.

40.002 Race Boat Numbers shall contain not more than three (3) digits and shall range from Number 3 through Number 999. No two Thundercats for APBA racing can have the same number. This includes all classes. Numbers shall contrast vividly with the color of the hull. The minimum height of each number shall be $12'' \pm 1/2''$; minimum width shall be $6'' \pm 1/2''$; minimum stroke shall be $2'' \pm 1/2''$; minimum spacing between each number shall be $1'' \pm 1/2''$. The single exception to this is the number "1" when used with another digit, in which case the width may be narrower. Owners may affix their assigned numbers on each side of their boat on a nearly vertical surface in such a manner that is readily visible to officials and spectators. Numbers not meeting these rules, or any number that is unreadable or becomes unreadable during an event, will be scored at the discretion of the Scorer and/or Chief Referee of that event. Their decision is final. The assigned racing number(s) shall also be on the bottom of the hull (underside of tunnel).

40.003 Air Chambers Boats shall be inflated with atmospheric air or nitrogen gas only, in independent compartments. The boat shall be able to float even if one half of the compartments are out of service. Flexible foam highjackers are not allowed.

40.004 Rolled-up size The boat shall be deflatable, collapsible, foldable or rollable. No dismantled part may have a length greater than 1/3 (one third) of the full length of the inflated boat, excepting the floor stretchers. The largest individual piece shall not exceed 2/3 (two-thirds) of the overall length of the inflated boat.

40.005 The Hull The inflatable keel shall extend along the whole floor length of the boat. No materials other than air may be inserted into, attached to or placed between the floorboards and keel. No rigid element is to be attached to the underside of the keel. "Rigid" describes any lamination or material that cannot be bent back 180 degrees upon itself with a maximum of 1/2" radius without deformation or degradation. Manufacturers or importers applying for homologation may be required to submit samples to validate their compliance to this rule.

40.006 Wings No aerodynamic appendages are allowed.

40.007 Modifications Above Waterline are allowed. The waterline is the line taken when the empty boat is at rest in the water. The waterline is deemed to be below the bottom of the transom in the case of multi-hull type boats.

40.008 A Splash Plate may be fitted to the back of the transom. If this plate runs the full length of the transom, i.e: from pontoon to pontoon, then the width of this plate is restricted to 4.0". If the width of this plate exceeds 4.0", then its length is restricted to 6.0" across the back of the transom, but may protrude as far back towards the motor as required.

40.009 No Modifications Below Waterline are allowed.

40.010 Fuel Tanks Only plastic fuel tanks or flexible bladder style fuel cells shall be allowed.

40.011 Righting Rope All boats shall be fitted with a designated righting rope.

40.012 Foot Straps are recommended to be installed for both driver and co-driver, but are optional.

40.013 Steering System Tiller arm is the only steering system allowed.

50.000 ENGINE

50.001 Outboard Motor Only engines with a maximum of one (1) venturi per cylinder are allowed (X-Class is exempt). An outboard motor can be removed from the boat in a single unit, complete with its transmission; it does not transmit its power through the hull at any point. The engine shall be naturally aspirated. The unit, thus removed and placed ashore, shall be capable of being started, fed by its fuel tank. The mounting supports fixed to the boat, the control levers, the tachometer with its connection, the battery with its conductors and the fuel tank and the fuel lines do not form part of the motor unit. No turbocharged or supercharged engines shall be allowed. The attachment angle and height of the motor shall remain fixed while the boat is underway.

50.002 Homologation All motors must be homologated prior to acceptance. To be homologated as a standard production motor, an outboard motor shall be sold and advertised by an industrial firm as being manufactured in standard production series (with all parts interchangeable and with identical dimensions, weights and materials). No performance enhancement kits are permitted. No racing or specialty engines will be allowed. Motors can be updated or backdated to meet the homologation specifications. Bandit and Outlaw class terms for accepting a new motor are as follows: Data must be provided to support any changes or acceptance. The motors shall be judged on propeller shaft performance and weight per Thundercat technical rules. The manufacturer's rated horsepower or any other single factor will not be the deciding factor for class eligibility. Once a motor has been approved for competition it cannot be revoked. If a motor proves to have an overall advantage in its designated class, restrictions shall be applied to align it with the class average performance. The final decision can be made at any time during the racing season by the Thundercat Commission.

50.003 Applications for Motor Homologation must be sent to the Thundercat Chairman.

50.004 Cutoff Switches (Kills) Engines shall have two tether-activated ignition cutoff switches capable of stopping the engine if the driver or co-driver is separated from the boat. A cutoff switch shall consist of a line and plug or cap, electronically attached to the engine to facilitate its continuous operation. The length of the driver's cutoff switch tether shall not exceed 3'6". The co-driver's cutoff switch tether length shall not extend beyond the inside of the boat's transom. Cutoff switches shall be attached to the driver's and co-driver's wrist or life jacket by a breakaway device with a pull force greater than the switch's operating force. All competitors shall be connected to said individual ignition cutoff switches while on plane at a race site. No additional kill caps, plugs, etc. will be allowed. No toggle type switches are allowed. An offense will result in disqualification.

50.005 Power Trim and tilt units are not allowed to be functional.

50.006 Cooling System When the motor is in the water, cooling shall be effected by the motor's own circulating pump. External pickups or water pickups affixed to the boat are prohibited. NO nose cone pickups will be allowed. No impeller modifications shall be allowed. The water must exit the engine as designed by the manufacturer. The amount of water entering the exhaust system shall not be modified in any fashion.

a) Outlaw class is allowed to install nose cones with low water pickups.

b) All classes may relocate the RAW water exit port to the top of the engine block to help vent off steam.

50.007 Shifter An efficient control handle giving forward, neutral and astern movements is compulsory. The control handle for reverse gear, ready for use, shall be within reach of the driver. Astern maneuvering of the boat shall be possible by selection of reverse gear only. Experimental Class EXCLUDED.

50.008 Starter An electric or manual starter shall ensure a quick and easy start without external aids. It shall be used as supplied by the manufacturer; no adjustments or alterations shall be allowed. If electric start is used, the voltage shall be not greater than 12vdc.

50.009 Cowlings Specially manufactured, lightweight engine cowlings shall not be permitted. (Outlaw class may add air vents to stock cowlings. They may also change or add how the cowling is secured.)

50.010 Engines Shall Be Bolted to the transoms. Only one propulsion system shall be allowed per boat.

50.011 15" and 20" long shaft engines are legal.

50.012 Original Lower Units Gear boxes (lower units) and midsections shall be as originally manufactured for, and provided with, the manufacturer's engine and model.

50.013 Leading Edges of the gearbox may not be modified (Bandit only). Gearcases shall have a skeg attached. There are no requirements on the dimensions of the skeg.

50.014 Only Motor Fuel compounded of standard pump gasoline, and petroleum oil and/or synthetic oil shall be used. The baseline for determining legal fuel will be a zero reading on a digatron meter or equivalent as defined by the Inspection Manual. At each regatta the inspector may purchase a sample of local gasoline, mix it with TCIII oil at a ratio of 20:1 and test it according to the Technical Manual. If the test fuel exceeds the zero digatron threshold, the higher reading will become the maximum limit of the day. The source and grade of the gasoline must be announced when registration opens. At that time, testing equipment must be available to all competitors. The fuel of the day rule is not applicable at straightaway or record races, championships, Nationals or Marathon Nationals. Any driver using fuel which does not meet this rule will be disqualified. Additional fuel disqualification in the same day will result in the driver being automatically suspended for the remainder of the day. A driver may appeal a fuel disqualification by following the appeal procedure before leaving the inspection area, so a fuel sample can be collected with complete assurance that there has been no substitution or addition. Other tests will be performed. All costs for transportation and such tests will be assessed against the appealing member. It is advisable to have unknown gasoline and oil checked before competition. Guidelines for fuel inspection procedure and equipment are contained in the inspection manual.

50.015 Special Racing Fuels Additives which produce power in excess of that produced by standard pump gasoline and petroleum base oil, shall not be permitted. See APBA General Safety Rule 26. A contestant appealing a fuel disqualification must bear the expense of the fuel analysis and handling. Nitrous oxide injection units are also prohibited.

50.016 Exhaust Pipes Any style is permitted as long as the exhaust gas enters and exits the tower housing.

50.100 SOLE MODIFICATIONS ALLOWED

50.101 The Original Propeller may be replaced by any other, as long as the replacement is freely available. It may be tuned or repitched. The locking nut, spacer, adapter, split pin and washers are free for the securing of the propeller. Rebushing and keying of propellers are allowed.

50.102 Tiller The steering bar and brackets may be reinforced and additional steering bars may be mounted. The steering bars shall be able to tilt

independently from the motor. Strengthening of transom bracket pivot bracket and midsection are permitted. If modifications result in openings in the cowling they shall be sealed. No alterations shall be made to increase steering travel.

50.103 Steering Dampening Or Force Reduction Any dampening or force reduction device can be added, removed or altered to counteract or modify tiller torque loads and/or dampening properties. Final decisions pertaining to the safety of these devices will be made by the Inspector. It is highly recommended that a dampening device be added to the steering system to help control erratic boat handling in the interest of safety. The motor must be maneuverable to be able to navigate the course. The inspector has the authority to determine if a motor is maneuverable.

50.104 Spark Plugs and spark plug caps may be replaced by others having the same dimensions as manufacturer recommendation.

50.105 Tuning The carburetion and ignition advance controls may be tuned differently, but without altering the original parts except that jets may be substituted. No additional timing devices are allowed.

50.106 Gauges Any monitoring device may be added.

50.107 Oil Injection All auto lube systems may be removed, together with parts related thereto. However, any openings in the cowling created by such removal shall be sealed.

50.108 Cylinders: Reboring up to 0.030" maximum on all cylinders and resleeving is permitted. **Exhaust relief slot not required in Outlaw.**

50.109 Motor Mounts The rubber mounts of the motor may be altered, pinned or replaced with solid mounts or aftermarket fabricated design.

50.110 Motor Lockdown Device Motor locking brackets may be removed or altered. However, inadvertent tilting of the engine shall be restricted by the use of cables, bungee cords, straps, etc., to be approved by the inspector prior to racing.

50.111 Screws, Nuts and Bolts The replacement of nuts, bolts, screws or the addition of lock nuts, drilling and wiring, split-pinning or keying is allowed provided the screws and pins are similar in design.

50.112 Neutral Safety Switch The gear interlock device may be removed or disabled.

50.113 Baffle Plates in carburetor fuel bowls to prevent fuel slosh are permitted.

50.114 Cowling Attachment The motor cowling may be secured by means other than or in addition to the standard means.

50.115 Tell-Tale Cooling Pipe may be replaced with another pipe of different characteristics, as long as the I.D. of the exit orifice is the same as manufactures.

50.116 Replacement Parts No part of the motor can be changed with another manufacturer's or pirate part except if it meets the original manufacturer's specifications. The tiller arm, tiller arm bracket, gear change lever and propeller may be changed with any other designed or manufactured part. Aftermarket parts are permitted if they meet manufacturer's specifications.

50.117 Lower Unit Modifications Gearboxes (lower units) may have the paint removed and may be polished only from the point of attachment to the midsection down.

50.118 A Torque Tab may be affixed to the trailing edge of the skeg on the lower unit to counteract propeller torque. Torque tabs on the underside of the splash plate may be removed or modified.

50.119 Kill Switch The ignition cutoff device (kill switch) may be replaced with any approved replacement switch.

50.120 Rev-Limiters Overspeed switches may be removed as well as charging coils.

50.121 Carburetor Springs may be added, altered or removed to the throttle lever of the carburetors.

50.122 Blueprinting Engines may be "blueprinted"; i.e. parts or ports where a dimension or a weight is quoted in the homologation sheets (published inspection/specification sheet) may be machined, altered or polished for the purpose of reaching that specific measurement or weight. The shape of the part machined, altered or polished may not change (i.e.: d, ports, etc.) Casting material may be removed where the ports meet the cylinder sleeve to match the specification sheet dimensions (i.e.: port to casting overlap). No material may be added to the casting where the port meets the cylinder sleeve (Mercury/Mariner 59 ci excluded **for Bandit**).

50.123 Crankshaft The crank may be welded or pinned as long as the dimensions of the crank after welding do not exceed the original manufacturer's dimensions and weight for the crank. Any pins may not exceed 1/2" in length (Mercury/Mariner 59 ci excluded).

50.124 Part Weight A part, the weight of which is quoted in the homologation report, may be machined for the purpose of reaching that specific weight or size but without altering other measures not listed for the part in question. It is not allowed to change the flywheel, but balancing machining is allowed (Mercury/Mariner 59 ci excluded).

50.125 Air Boxes may be removed.

50.126 Reeds Plastic/fiber reeds of any manufacture shall be allowed, and reed stops may be removed or altered.

50.127 Exhaust Holes A 1- 1/32" (one and one-thirty-second of an inch) diameter maximum exhaust relief hole shall be allowed on each side of the gearcase only. This dimension may be measured in any two directions.

50.128 Muffler A maximum of two inches of the casing (muffler) surrounding the exhaust tuner may be removed from the bottom up (Mercury/Mariner 59 ci excluded). The Tohatsu/Nissan/Yamaha muffler may be removed, and exhaust tuner may be modified.

50.129 Chokes/Primers may be modified, replaced or removed (Mercury/Mariner 59 ci excluded).

50.130 Thermostats and pressure valves of the cooling system may be removed.

60.000 HEATS

60.001 Distance of Closed Course Each heat shall be a maximum of approximately five (5) miles and shall be a minimum of three (3) laps. However, the Referee is empowered to reduce the number of laps if, in his/her judgment, such action would be in the best interests of the race sponsor and the drivers.

60.002 Distance of Marathon Course Each heat shall not be less than 20 minutes or 15 miles in length from start to finish. The race may consist of one or two heats. If the race consists of two heats, they shall be on successive days and the winner in each class shall be determined on the basis of total points scored in the two heats.

60.003 Number of Boats To receive national points there shall be a minimum of three bona fide starters. For stationary starts, every boat lined up in a starting position at the starting dock when the flag drops will be considered a legal starter. The minimum boat count for all National/Divisional events shall include no more than one of each competitor's equipment. There shall be a maximum of 15 boats in a class allowed on the course during a race. In the event of there being more than 15 boats in a class, elimination heats shall be run as follows:

- The boats shall be divided into equal sections by lottery, and each section will run two qualifying heats.
- The top qualifiers in each section will go forward into a final heat with no more than 15 boats in a class.

60.004 Heats / Race Unless otherwise specified, a minimum of two heats shall constitute a race. (Three or more are preferred).

70.000 STARTING

70.001 Stationary Start Positions The line-up position for the first heat races shall be determined by lottery at the drivers meeting. In elimination, qualifying, and all following heats the line-up position shall be the reverse order of finish of the previous heat. If there are elimination heats, the line-up position for the final heat shall be determined by the elimination heat finish.

70.002 Jumping The Start Any driver who jumps the gun/start shall be penalized one lap or one minute.

70.003 What Start To Use All starts such as Le Mans, Dock, Jetty, or Clock starts shall follow General Racing Rules. The start type may be determined by the referee, race committee or starter.

Floating Start:

- a) The boat will be in the water with the driver and co-driver standing next to the boat.
- b) The boats will be spaced no closer than 10 feet apart.
- c) All the boats will line up even with each other.
- d) One minute before the start of the race the white flag will be raised and then lowered.
- e) 15 seconds before the start of the race the green flag will be raised.
- f) At this time the driver and co-driver shall raise their kill switch devices over their heads, and hold them up until the green flag is dropped.
- g) The official start of the race will be given by dropping the green flag. The driver and co-driver may then board, install their kill switch devices, and start the motor.
- h) Only after both members of the crew are in the boat may the driver get underway.

70.004 All Drivers Shall Hold Their Lanes until they are completely around the first turn buoy or commitment buoy. For Clock Starts: Drivers must hold their lane from Start/Finish line until around First Pin/Turn One.

80.000 COURSE

80.001 A Race Will Be Stopped if any competitor lands in the water while under starter's orders or during a race. All competitors shall stop their boats immediately, with or without a red flag or flare being raised. When the black flag is raised the competitors may return to the start positions. A restart shall be of the same type originally used.

80.002 Restarts If a race is stopped before 2/3 of the distance has been covered by the first boat, drivers shall return immediately to the starting area and be ready for an immediate restart. The driver(s) responsible for the stoppage shall not be eligible for the restart at the least advantageous position for that heat. There shall be no refueling allowed. The remaining distance of the heat shall be diminished by one lap. Any boat disqualified for a driving infraction other than jumping the gun will not be allowed to restart. Restarts are given as soon as the circuit is cleared. No new entries will be accepted for a restarted race/heat. A stopped race may only be restarted twice. No restart is allowed after completion of 2/3 of the heat.

80.003 Passing An overlap can only be established when the two boats are on the same course, or approximately on the same course. An overlap is established when the overtaking boat has passed the overtaken boat sufficiently to change lanes with 15 feet between the two boats (stern to bow). The following rules shall apply to an overlap:

- a) The lead boat has the right of way until an overlap is established.
- b) A safe overlap is the responsibility of the overtaking boat.
- c) Once an overlap is established, the overtaken boat must give the overtaking boat room to clear any course markers.
- d) The overtaking boat cannot force an overlap after the lead boat has begun to alter course to negotiate a turn.
- e) An overlap can occur from the port or starboard.
- f) "Bearing Away" is as defined in the General Racing Rules, from either port or starboard, in Thundercat racing.

80.004 Missing A Turn A boat that misses a turn will be assessed a one-lap penalty. A boat is not allowed to round the mark again after missing the buoy. The referee may, with or without a protest, penalize any boat that has committed a breach of these rules, before the awarding of prizes.

80.005 No Outside Assistance No team shall take on fuel, supplies or equipment from an outside source prior to crossing the finish line. That team shall be disqualified if they do so. A team shall also be disqualified if they accept any outside assistance to effect repairs, to dislodge craft after having run aground, or any assistance that would enable a disabled race boat to continue the race, such as accepting a tow or negotiating any part of the course using any facility except its own power. The exception to this rule is a point-to-point marathon race.

80.006 Bumping a Buoy Damaging or dislodging a buoy will result in a one-lap penalty for that heat, except when a competitor is forced into a buoy by overlap violation.

80.007 Warnings Any driver who is warned by a referee for dangerous driving shall have his license marked to reflect this warning. On the driver's receiving a second warning during a season he/she will be disqualified from the event as well as receiving a one-month suspension from all races or fine set by the Thundercat Commission.

90.000 INSPECTIONS

90.001 Safety Inspection Annual technical boat safety inspection is required prior to competition. Motors must be mounted and boats must be rigged for competition before this inspection can take place. A sticker shall be affixed if the boat meets all safety requirements. Such approval expires each October 31st. Stickers will be furnished by the Thundercat Racing Commission. If a boat does not pass, the driver must be warned and told to fix the problem before competing in the next heat/race. If he/she fails to do so, a disqualification will result.

Each entry will receive a technical boat safety inspection review prior to competing in an event. If a boat does not pass, the driver must be warned and told to fix the problem before competing in the next heat/race. If he/she fails to do so, a disqualification will result.

90.002 Procedure

- a) Immediately after the finish of each heat or race, as established at the drivers meeting, contestants shall report with their boats to the place designated by the Race Committee or Inspector. The boat and motor shall remain in the custody of the Inspector until dismissed. For the purpose of enforcement of technical rules, the engine and boat shall be assumed to have been raced in the same condition in which it appears during post-race inspection.
- b) The Inspectors shall have the power after the finish of any race to inspect any or all contestants. Any contestant refusing to comply with the orders of the Inspector or Pit Manager or who violates the provision of section c) shall be disqualified by the Race Committee.

- c) Each winning boat and motor and such others as designated by the Race Committee or Inspector shall be inspected. The Referee may waive inspection under special circumstances. Inspection may not be waived for championship regattas, or if a protest has been filed, or if a record has been claimed.
- d) At National Championship and Record events, a mandatory inspection of the top three finishers in each class competing shall undergo a complete inspection. The first place finisher will undergo a complete teardown inspection to insure compliance with Thundercat rules.
- e) The driver shall be responsible for the condition of the motor and boat as raced. Errors on the part of the manufacturer, boat builder, mechanic or previous owner shall not excuse noncompliance with the rules.
- f) The Referee shall record all disqualifications and forward all appropriate paperwork to APBA Headquarters. The following will result in disqualification:
 - 1) A driver does not report with his boat to the Inspector directly after a race for inspection.
 - 2) A driver refuses to dismantle his engine when asked to by the Inspector.
 - 3) A driver forfeits a race rather than submit to inspection.
 - 4) In the opinion of the Inspector, the driver has defied the rule and competed with non-compliant equipment.
- g) In case of infractions of any technical rules during a heat, the driver shall be disqualified from that heat and all other heats of the race. The order of finish shall be recalculated.
- h) Boats, and engines taking part in a race that are subject to inspection, shall not leave the race site until released by the Inspector. The inspector reserves the right to mark motors if the event is over several days.
- i) For special cases involving the use of special tools and equipment, the Inspector may postpone the inspection and stipulate the time and place where the motor(s) shall be made available. In the meantime, the motor shall remain sealed to prevent any alterations being made.
- j) Only the following people are allowed in the inspection area:
 - 1) The Referee;
 - 2) The Inspectors;
 - 3) The driver and one mechanic.

The presence of other persons is only allowed if authorized by the Referee or Chief Inspector.

90.003 Additional Specifications Refer to the separate Inspection Manual for further clarification of Boat / Motor specifications and inspection procedures not covered in this section.

100.000 PROTEST & APPEAL

100.001 Protest to Referee Only the Referee can accept a protest; protests may not be made to the Commission directly.

100.002 Before Start Protest regarding the qualification of a boat, motor, owner or driver, the validity of an entry or of the rules or handicap shall be made before the first start to the referee in writing.

100.003 After Race Any protest lodged within one hour of the finish of a race will not be taken into consideration unless the protester can prove the facts were unknown to him before the start.

100.004 The Protest Process

- a) Any driver may protest a violation of the rules in any event in which he/she takes part. All protests are to be in writing, signed, and as complete as possible, with the following supporting documents, when applicable:
 - 1) Race instructions;
 - 2) Plan showing the position of the boats;
 - 3) Explanation of the incident (stating rule infringed);
 - 4) Any other documents which the protester deems useful.
- b) A \$100.00 protest filing fee is required to defray the cost associated with the protest. Any amount after costs shall be deposited in the Thundercat Inspection fund. For Technical Protest fees, see 100.010.
- c) Protests involving the sanction or the manner in which a regatta is being conducted must be made within sufficient time to allow the alleged violation to be corrected.
- d) Protests involving an alleged safety violation will only result in a disqualification after the offending driver has been warned and allowed to comply with the rule in question.

100.005 Withdrawing A written protest may only be withdrawn at the discretion of the Referee.

100.006 Acting On Protest Should the Referee decide that all requirements for protest have been met, he/she shall accept the protest and act on it as soon as possible. The written protest or a copy thereof shall be made available to all teams involved, and each shall be notified of the protest so that their testimony can be taken. The decision of the referee shall be made promptly, and communicated to all parties concerned.

100.007 Hearing

- a) The Race Committee shall hear the protest by conducting a hearing. The format shall be at the Race Committee's discretion; however, the involved parties shall both have the right to be heard and to call witnesses or present evidence. Decisions regarding procedures shall be decided by majority vote.
- b) If a technical violation is alleged, the Inspector shall perform an inspection of the equipment that is subject to the protest and shall present a report to the Race Committee. In such case, the Inspector shall be disqualified from voting on the protest in question.
- c) The race committee may seek assistance or advice regarding the protest from any outside source that it deems appropriate.
- d) The Race Committee shall then consider the protest and render a decision. A majority vote will decide the question. Any protest that is not ruled upon by the Race Committee within forty-eight (48) hours after being filed shall be deemed overruled.
- e) The Race Committee shall next impose a sanction, which may include a warning or disqualification. An Inspector who gives testimony regarding a technical rule may vote in the penalty phase.

100.008 Technical Violation Contestants shall have the right to protest technical violations of these rules by a competitor. Technical rules are those governing the qualifications of the race boat itself; its engine, its structure, its conformance with rules describing its eligibility to compete in its class.

100.009 Illegal Equipment Should the protest be proved valid, the protested party shall lose all points and prizes for that racing event. When a clear violation of a technical rule results in the upholding of a second protest, the driver and/or owner may be stripped of all accumulated points and disciplined under Article XVI of APBA By-Laws. Such discipline may include suspension of membership for up to one year.

100.010 Competitor's Engine Protest

Stage I - A \$300 Fee shall accompany an engine protest for a Stage I inspection.

- 1) The owner or his crew shall remove the intake manifold and a cylinder head as instructed by the inspector.
- 2) The inspector shall measure port sizes, displacement, compression, venturi sizes, and check for compliance with any or all technical rules and/or specifications at his discretion, limited only by the extent of teardown indicated by paragraph 1 above.

Stage II - A \$500 Fee shall accompany an engine protest for a Stage 2 inspection.

- 1) The owner or his crew shall remove the powerhead, exhaust plate, and lower unit from the center section; remove the intake manifold, cylinder head, and all pistons from the powerhead; and disassemble the crankcase.
- 2) The inspector shall measure or otherwise check any or all parts of the motor to determine compliance with all or any technical rules and/or specifications at his discretion, limited only by the extent of teardown indicated by paragraph I above.-

If the engine protest is upheld, the fee shall be returned to the protesting party. Should the protest be found invalid, the protest fee shall be paid to the driver of the protested boat to defray the cost of teardown.

100.011 Appeal to Race If a competitor has been notified in writing prior to a race of his failure to comply with any rule or specification set forth herein, that competitor or his representative may give a \$300 fee and written notice to the Referee of his intention to file an appeal to the Race Committee from that decision rendered by the Inspector and/or the Referee. In this case the Referee shall (except in cases involving intoxicants and unmanageable and unsafe craft rulings) allow the race boat to start. The Race Committee shall give both sides an opportunity to present their case, and shall deem results of that class unofficial pending the outcome of a hearing. Should the Race Committee rule that the appeal is justified, the performance of the race boat in question shall be considered to be official. Should the appeal be denied, the performance shall be unrecorded, and the protest fee retained by the Thundercat Commission.

100.012 Appeal to the Thundercat Racing Commission

- a) Any party to a protest may appeal an adverse decision of the Race Committee or the Referee, notwithstanding General Racing Rule 23. An appeal may be made by filing a written statement of the appeal with the Referee along with a \$100 filing fee. The filing fees shall be used to defray the cost associated with the appeal and any amount after costs shall be deposited in the Thundercat Promotional Fund.
- b) Appeals to the Thundercat Commission shall be made to the Thundercat Chairman within 14 days of hearing results of the protest.
- c) The Thundercat Commission shall hear the appeal by conducting a hearing via telephone, mail, or the Internet if appropriate. The format shall be at the Thundercat Commission's discretion; however, the involved parties shall both have the right to be heard and to call witnesses or present evidence. In appeals not conducted in person, the right to be heard is limited to submitting evidence. Decisions regarding procedures shall be decided by majority vote.
- d) If a technical violation is alleged, the Inspector shall perform an inspection of the equipment which is subject to the appeal, and shall present a report to the Thundercat Commission.
- e) The race committee may seek assistance or advice regarding the appeal from any outside source that it deems appropriate. However, in the case of a technical violation, the Thundercat Commission shall consult with the appropriate technical committee.
- f) The Thundercat Commission shall then consider the appeal and render a decision. A majority vote will decide the question. Any appeal that is not ruled upon by the Commission within thirty (30) days after being filed shall be automatically denied. The decision of the Commission is final and may not be further appealed.
- g) A driver who appeals a suspension may continue to race until his appeal is decided by the Commission.

110.000 PENALTIES

110.001 Penalties No individual who has been expelled from APBA or who is currently under suspension by the APBA or the Thundercat Commission shall be permitted to officiate, serve as a Race Commission member, act in any capacity of assistance, or participate as a boat owner, driver or crew member in any sanctioned racing event. No boat belonging to that individual shall be allowed to compete nor shall it be chartered or otherwise transferred except by final sale to render it eligible for a sanctioned race. Any owner, driver, or crew member who is an APBA member and who is formally charged or indicted for a felony will be subject to a Thundercat Commission hearing to determine if suspension is appropriate. Concurrently therewith charges shall be filed against said individual under APBA By-Laws Article XVI for further action. Additionally, any APBA-registered boat owned by suspended individuals shall be barred from competition during the period of suspension. The Thundercat Commission will hear an appeal as soon as practical. If the accused has not been found guilty in a court of law, he/she shall be put on probation, permitted to race, and keep the Thundercat Commission informed in writing of his status (i.e., trial dates, exoneration etc.). If found guilty in a court of law (regardless of appeals) a competitor's racing points and awards may be stripped for any racing season by the Thundercat Commission. Further, the Hall of Champions induction cannot be awarded to a driver on probation or convicted of a felony. Any driver or riding crew member who is suspended will not receive cash prizes. The money will be placed by the Thundercat Commission in an account and will be paid to the person on probation when he/she is exonerated. If the contestant is convicted in a court of law and therefore suspended or expelled by the Thundercat Commission and/or the APBA, his/her prize money will be retained by the Thundercat Commission.

110.002 Non-Member in Boat Any owner who permits a non-racing member to utilize his/her equipment in a sanctioned race shall be suspended for 30 days.

110.003 Any Breach of These Rules which is deemed by the Referee as being of a major nature, contrary to the best interests of power boat racing, or deemed to constitute unsportsmanlike conduct, may subject such offender to disqualification, suspension or any combination thereof. Such suspension shall be considered temporary but shall remain in effect until such time as the matter shall have been disposed of in accordance with Article XV of the bylaws of APBA.

110.004 Referee's Discretion Where no specific rule violation penalties have been assigned in these rules, the Referee shall determine the legitimacy of the violation and the resultant penalty. In no case shall position penalties be used.

110.005 Suspension The Referee may temporarily suspend a driver who has knowingly committed a breach of the APBA rules, for the event during which an offense has been committed.

110.006 Prolonged Suspension

- a) The Thundercat Commission may impose a prolonged suspension or fine on any competitor or member who has committed a serious moral

or sporting offense. The suspension may be immediate in a serious case.

- b) The suspended member is not allowed to take part in any competition so long as the suspension lasts.

110.007 Abuse or Assault Any contestant or member of his crew (including those on shore) is subject to penalties not to exceed one year suspension at the discretion of the Referee for verbal abuse or physical assault on a race official.

110.008 Decisions Upon receipt of a report of misconduct, the Thundercat Commission shall conduct an investigation and, when appropriate, a hearing; and take such action as it deems appropriate against those involved.

120.000 POINTS, SCORING AND TITLES

120.001 Points For determining final standings of a race, the driver will receive points according to General Racing Rule 21, paragraph 2 through 5. Points will be awarded for each day of racing. There will be no bonus points awarded to winners of any Thundercat race.

120.002 Divisions

The Divisions are as follows:

- Eastern Division - Regions 1, 2, 3 and 4
- Southern Division - Regions 5, 9, 14 and 15
- Central Division - Regions 6, 7, and 8
- Western Division - Regions 10, 11, 12, 16

120.003 Number of Boats There shall be a minimum of three legitimate starters in the first heat of competition for a given class, in which points can be awarded for all heats in the race. In order for any National title to be awarded, there shall be a minimum of three legitimate starters in the first heat of competition for a given class.

120.004 "Step up" Bandits and/or P750 may "step-up" to Outlaw or X-Class as long as the driver and co-driver meet minimum age for the class they would like to "step-up" to.

120.005 1-US - US-1 - US-2

- a) The driver who wins the Marathon National Championship shall be allowed to display US-2 as his/her racing number for the following season.
- b) The driver who wins the National Closed Course Championship shall be allowed to display 1-US as his/her racing number for the following season.
- c) The driver who wins the National High Points shall be allowed to display US-1 as his/her racing number for the following season.

120.006 High Point Champions shall be decided based on the total amount of driver points scored from November 1st through October 31st. In each class the driver having the highest points for these races shall be awarded US-1. A minimum of five races will be required in order to win the High Points Title.

120.007 Championship Regattas During each racing year, Championship regattas shall be as follows:

1. Closed Course National Championship

- a) Referee, Inspector, and Scorer for Thundercat National Championships must be approved by Thundercat Racing Commission before granting sanctions.
- b) A National Closed Course Championship must offer two days of racing, with a minimum of two heats per day per class.
- c) The combined total points for all four (4) heats shall determine the Closed Course National Championship. High Points will be determined by the chart in General Racing Rule 21, paragraph 2. In the event of a tie, the competitor with the least elapsed times for all heats combined shall prevail.
- d) Closed course championships must be announced to APBA Thundercat members one (1) month prior to the race.

2. Marathon National Championship

- a) To qualify as a Marathon National Championship event, the event must offer two days of racing with a minimum of 40 miles of racing per day.
- b) Each day of racing shall establish the standings for that day. National High Points will be awarded for each day of racing. The combined total points for both days shall determine the Marathon National Champion. High Points will be determined by the chart in General Racing Rule 21, paragraph 2. In the event of a tie, the competitor with the least elapsed times for both days shall prevail. If a tie still exists, the participant with the highest class standing within his/her class on that day shall prevail.

3. Divisional Championship

- a) There shall be one Western, one Southern, one Eastern, and one Central Divisional Championship. Divisionals shall be held prior to the Closed Course National Championship Events. All registered boats are eligible to compete in all Divisional races. In order to obtain points toward the Hall of Champions the competitor must live in the geographic division.

4. North American Championship

- a) Must offer two days of racing and two (2) heats per day in each class.
- b) The combined total points for all four (4) heats shall determine the North American Champion. High Points will be determined by the chart in General Racing Rule 21, paragraph 2. In the event of a tie, the competitor with the least elapsed times for all heats combined shall prevail.

120.008 Record Courses The Thundercat Commission recognizes any APBA category's record courses as official. These courses shall be run in accordance with the provisions of that category to establish a record. The Thundercat Commission shall also recognize the recommended Thundercat course for competition records (a 400 yard x 200 yard rectangle).

120.009 Hall Of Champions Criteria (Thundercat drivers are not currently eligible.)

1. Eligibility: To be considered for induction, the driver(s) must have won:
 - a) A Closed Course National Championship, Marathon National Championship or a National High Points title; AND
 - b) at least one additional item listed below.
2. Once eligibility is established, points will be awarded as follows:
 - National High Points Championship (2 points)
 - Closed Course National Champion. (5 points)

- North American Championship (5 points)
- Marathon National Champion (5 points)
- Division Championship (3 points)
- Closed Course World Record (2 points)
- Straightaway World Record (2 points)

3. In the event of a tie, the following tiebreakers apply:

- a) The winner will be the driver with the greatest number of races.
- b) If there is still a tie, the winner will be the driver with the greatest number of points from all races.
- c) If there is still a tie, the winner will be the driver with the greatest number of wet boats in his/her class.

4. Any unsportsmanlike conduct/misconduct penalties assessed by a race site referee during the year removes the candidate from the induction process.

120.010 Titles Committee The Thundercat Chairman shall appoint a committee consisting of three (3) members whose sole purpose is tabulation and figuring of the following:

- Hall of Champions Inductee
- Divisional High Point Champions
- National High Point Champion (US-1)
- National Marathon Champion (US-2)
- National Closed Course Champion (1-US)

They shall report to the chairman all findings by November 30th.

120.011 Right to Review and Correct The Thundercat Racing Commission shall have the power to review and correct any and all paperwork from APBA Thundercat races and time trials up to 90 days after the event, but no later than the close of Thundercat business at the Annual Meeting.

130.000 PRIZE MONEY AND TROPHIES

130.001 No Trophies or Prizes Will Be Awarded until all protests or appeals are settled and official results are posted.

130.002 Over and Above The sponsoring organization may designate any special prizes or cash awards.

130.003 Prize Money shall be the sole responsibility of the conducting club.

130.004 Purse Split It is recommended that all purse money be split evenly among all legal competitors, in all classes.

140.000 COMMISSION

140.001 A Technical Commission may be appointed by the Thundercat Chairman to advise the Chairman and Commission members on matters of technical nature.

140.002 Commission Decisions Are Final The Thundercat Commission reserves the right to make final and binding decisions for the good of the sport. Regarding interpretation and clarification of the technical rules, the Thundercat Commission shall maintain an open door policy to all questions and suggestions by interested parties.

140.003 Expense Money Any out of the ordinary expenses that may burden the Thundercat Commission, in the verification or confirmation of technical matters, may be the responsibility of the member involved in an individual issue.

140.004 Expenditures Any expenditures of APBA Thundercat funds must be approved by ALL chair/committee members.

150.000 CHANGES TO RULES AND POLICIES

150.001 Rule Changes In the interest of safety and equitable competition, these Rules and Policies are subject to change. Proposed changes to these Rules and Policies may be submitted in writing by any active racing member of APBA, and shall be accompanied by the signatures of 25% of the Thundercat membership. The proposed changes shall be sent to the Thundercat Chairman, to be approved or disapproved by the Thundercat Commission at the APBA National Meeting with the attending Commission and Chairman.

150.002 Announce Rule Changes Any rule change, or technical interpretations by the Technical Commission, not published in the annual rule book shall be printed in Propeller magazine and on the APBA website, and will be effective 30 days from the date of publication. This does not apply to emergency and safety rule changes.

160.000 RESCUE CRITERIA

160.001 Personnel And Staffing

- a) When race boats are on the course, there should be two rescue boats on the water at all times. Each should have a boat operator and at least two other personnel on board. It is recommended that one person in each rescue boat be an emergency medical technician (EMT).
- b) Alcohol is prohibited on any rescue boat. Caution should be exercised to insure that prescribed and non-prescribed medications do not alter the rescuer's ability to perform his/her duties.
- c) The race director, referee, or their designee shall have the discretion to place a rescuer off duty if he/she determines that the rescuer is performing ineffectively or is endangering their own or others' safety.
- d) Rescue boat personnel on board during the race should be limited to the number required to carry out assigned functions.

160.002 Equipment

- a) At least two rescue boats, each capable of transporting at least one victim in a horizontal position on a rigid immobilization device, are required at each regatta. Personal watercraft are not considered rescue boats.
- b) Each rescue boat shall contain a personal flotation device (PFD) for each occupant.
- c) Each rescue boat shall have communication equipment sufficient to ensure adequate communications between the rescue boats and the judge's stand.
- d) Each rescue boat should contain a rigid body immobilization device, such as a backboard or "Stokes" basket, BLS trauma kit, airway management devices which shall include a bag-valve mask, and body substance isolation devices, and liquid detergent for hand washing and field decontamination.

- e) Each rescue boat should contain a fire extinguisher.
- f) Each rescue boat should contain a device capable of cutting cut-resistant clothing (such as a “Spideco” knife, or shears designed to cut cut-resistant clothing).

160.003 Procedure

- a) Each occupant of each rescue boat must properly wear a PFD while race boats are on the water.
- b) Rescue boats shall be operated in such a manner as to avoid creating wakes except under emergency response conditions.
- c) Rescue boat personnel shall meet with the race director, referee, or their designee for instructions prior to the beginning of each sanctioned event. All rescue personnel shall be instructed in the meaning of signal flags, driver hand signals, how to conduct themselves, their position on the course, what to watch for, and how to respond in case of an emergency. The importance of moving slowly in a non-emergency situation in order to avoid creating a wake should be stressed.
- d) Rescue personnel shall immediately advise the judge’s stand if, in their opinion, an unsafe condition exists.
- e) All potentially injured racers shall be lifted from the water in as nearly a horizontal position as possible on a rigid body immobilization device. The rescue boat operator has full responsibility for the safe operation of the rescue boat, and the safety of rescuers and racers, at all times. The operator should be at all times aware of potential hazards in the water, including racers and rescue personnel. Speed of transit of patient to onshore care should be determined in concert with the rescue person in charge of the patient.
- f) The judge’s stand shall conduct a radio check with rescue crews prior to each heat. Radio communications during actual rescue should be kept to a minimum to allow rescue crews to focus on the injured driver.

170.000 P-750 CLASS, UIM TITLES/TEAMS

UIM P750 World Championship Series:

- 1. Must have at least two of the three classes - Stock, Pro Stock and Modified
- 2. Two countries (National Authorities) must enter in each class to validate a UIM World titled event.
- 3. All 3 disciplines must be contended at a single event over the duration of a minimum of 7 days including 2 lay-days.

UIM P750 Continental Championship Series:

- 1. Must have at least two of the three classes - Stock, Pro Stock and Modified
- 2. Two countries (National Authorities) must enter in each class to validate a UIM Continental event.
- 3. All 3 disciplines must be contended at a single event over the duration of a minimum of 4 days including 1 lay-day.

UIM Southern Hemisphere Championship & UIM Northern Hemisphere Championship:

- 1. Must have at least two of the three classes - Stock, Pro Stock and Modified
- 2. Two countries (National Authorities) must enter to validate a UIM Hemisphere Championship.
- 3. All 3 disciplines must be contended at a single event over the duration of a minimum of 4 days including 1 lay-day.

All Series Championships:

Can be staged at one event or be held during a calendar year at three separate venues/countries if allocated by the UIM P750 Working Group Committee and approved by Cominsport. Each venue/country organizing one of the disciplines must include a minimum of two days racing per discipline. A series staged solely at one event must have all three disciplines, no single discipline will be recognized for any UIM title. A series held over three separate venues / countries will be awarded one of the disciplines. All three disciplines must enjoy equal points awarding system and accumulated to award a final Championship title per class. A P750 Series is made up of three individual disciplines.

WORLD AND CONTINENTAL CLASSES			
Rule:	STOCK (S):	PRO STOCK (PRO):	MODIFIED (M):
UIM World & Continental, Southern & Northern Hemisphere series.	YES	YES	YES

170.001 - O.O.D (Officer of the Day)

The UIM will approve the O.O.D for all UIM titled events. Main Officials must have experience in P750 Racing (Safety Officer, Timing and Technical)

170.002- PRIZE PRESENTATION

Prize presentation at UIM Titled events must be attended by all participants. Only the O.O.D can sanction a non-attendance.

170.003- MINIMUM BOATS NUMBERS AND NATIONAL AUTHORITIES

A minimum of three boats will constitute a valid class. For a UIM Titled event the minimum number of boats per class must be five and a minimum of two different countries (National Authorities).

170.004 - LICENSE DETAILS

All Drivers and Co-Drivers must hold a current International race license for P750 Class issued by their own National Authority for International championships and a National license as per driver or co-drivers National Authorities rules and regulations to compete nationally. UIM Rules 120.01, 120.02, 120.03, 120.04, 120.05, 120.06, and 120.07 will apply. Note: Competitors taking prescribed medication must complete the UIM ‘Therapeutic Use Exemptions TUE ‘Form For further information go to the UIM website - Anti Doping or contact your National Authority.

170.005- FINAL INSPECTION

The organisers must ensure that at least the winning boat and engine are inspected and measured to ensure legality. It is optional to inspect or measure other boats in second and third place or any other boat. UIM Rules 321.05 will apply.

170.006 - TEAMS

Team = the designated Driver and a Co-driver can contest these championships.

In the event of a Co-driver being injured, a replacement of the Co-driver only is permitted in all disciplines if:

- Doctor/Paramedic’s certificate is produced stating that the injury of the Co-driver.

The OOD is satisfied with the doctor/paramedic's report

The replacement Co-driver has the complete current paperwork including a current international license.

No Co-Driver can be changed during a heat, race or leg.

The Driver is the person in control of the engine, steering, throttle and gears

The Co-driver is the second person in the boat who is not the Driver.

The Co-driver does not have to be of the same Nationality as the Driver.

170.007 - MINIMUM AGE

Age refers at the date of the event.

TEAM	STOCK (S)	PRO STOCK (Pro)	MODIFIED (M)
Min Age of Driver	16	17	18
Min Age of Co-driver	16	16	16

170.008 - BEHAVIOUR

No abuse of officials will be tolerated. Any driver, Co-driver or team members found guilty by admission, or by the jury, will result in the driver/co-driver being disqualified from the heat or discipline or total event. Only the O.O.D. or the UIM Commissioner can take this action. After a finding of gross infringement of the rules or a gross breach of good manners or sportsmanship, not covered by the above rule, the O.O.D. and/or the Race Jury may exclude a competitor from a heat/discipline or the whole event.

170.009- PROTESTS

All protests, jury formation, sanctions, appeals are to be as the Rules Group 400 (as with all other UIM classes). A Team / Driver can only protest another Team / Driver if they are in the same race heat.

170.010 - PROTEST FEE

The protest fee must be announced in the advanced program Protest fee: maximum of 80 Euros or equivalent in host's currency

170.011- ALCOHOL/DRUGS

Alcohol or drug abuse will result in a total ban from the event (see rule 205.02.02 / 03). Note: Competitors taking prescribed medication must complete the UIM 'Therapeutic Use Exemptions TUE' Form For further information go to the UIM website - Anti Doping or contact your National Authority.

170.012- INSURANCES

All Drivers and Co-drivers must abide by any mandatory medical and insurances carefully set out in the advance program. Any costs charged by the organizers for supplying the same, must also be stipulated in the advance program Max 90 Euros or equivalent in host's currency.

170.013- PENALTIES/YELLOW/RED CARDS/BLUE CARDS

Rules 406 - Penalties will apply, although P750 Class penalties will supersede general rules. Yellow/Red/Blue cards: see rules 406.05 these rules will be strictly enforced.

170.014 - DRIVERS BRIEFING

Any Driver/ Co-driver failing to attend any drivers briefing without prior consent from the O.O.D will be disqualified at the discretion of the O.O.D

170.015 - SAFETY EQUIPMENT (see 20.000 for general Thundercat safety rules)

LIFEJACKETS: The efficiency of the lifejacket is the sole responsibility of the wearer who must be assured that it conforms to the UIM rules and carries indelible confirmation of this. Buoyancy: A lifejacket must have a minimum of 7.5 kg solid buoyancy for a person weighing up to 60 kgs and 9 kgs of buoyancy for those over 60 kg. A back support is highly recommended. As per UIM rule 205.06. If the lifejacket does not have a built in back support then body armor must be worn underneath.

CARRIED SAFETY EQUIPMENT: Safety equipment as specified in each discipline must be carried at all times. Failure to do so will involve penalties as described in the relevant discipline. The boat number must be marked on all safety equipment.

EYE PROTECTION: Eye protection is mandatory in the Circuit and Surf discipline and advised for Long-haul. This protection must be goggles or helmet face shield that covers the eyes.

170.016 - CLASSES/HULLS

561 Reference UIM rule 501 Measurement Certificate of the general rules - Measurement certificates are not required for P750.

170.017 - DISCIPLINES

M Shape (Surf); Circuit and Long-haul

170.018 - HULLS				
Number	Rule:	STOCK (S):	PRO STOCK (PRO):	MODIFIED (M):
.011	Engine Capacity	Up to 750cc	Up to 750cc	Up to 750cc
.012	Minimum hull length	3.8m	3.8m	3.8m
.013	Minimum hull width	1.7m	1.7m	1.7m
.014	Minimum hull weight	165kg	165kg	160kg
.015	Minimum overall weight	325kg	325kg	320kg

Minimum hull / engine weight

170.017.1 The above mentioned weight is the minimum weight of a complete rig, weighed directly after the race without crew and their personal equipment or residual water, without fuel tanks. The Driver & Co-Driver must still meet the minimum overall weight.

Minimum overall weight

170.017.2 - includes 170.017.1 plus Driver & Co-Driver with their personal safety equipment on that they have just raced in - life jacket, helmet,

wetsuit or dry suit. To reach the minimum overall weight, ballast can be added. This must be securely placed and has to be of solid material and not liquid material.

170.019 - HULL DESIGN

All boats must be of a tunnel hull design and conform to the original manufacturer’s catalogue THE FLOORBOARDS CAN BE SUPPLIED BY AN ALTERNATIVE MANUFACTURE BUT MUST CONFORM TO RULE 170.021. All boats must be fitted with a serial number plate issued by the manufacturer on either the nose cone or preferably the transom, showing the Model, Make, Date of Manufacture and if possible the maximum allowed horsepower of any relevant engine. A minimum number of 2 boats must have been made, advertised for sale and are commercially available before the model can be accepted to race. As long as the boats fit to the Class hull requirements, no measurement certificate is required as they are inflatable boats. All boats must conform to the following measurements:

SKETCHES: Measurements Number 4: minimum of 0.26m. Rear Transom to ground: Between Hi-jackers at rear measured at nearest points: Number 8: Minimum of 1.05m. Overall width front transom (measurement taken at back of nose cone). Other measurements to be added by agreement

HULL DIAGRAM A:

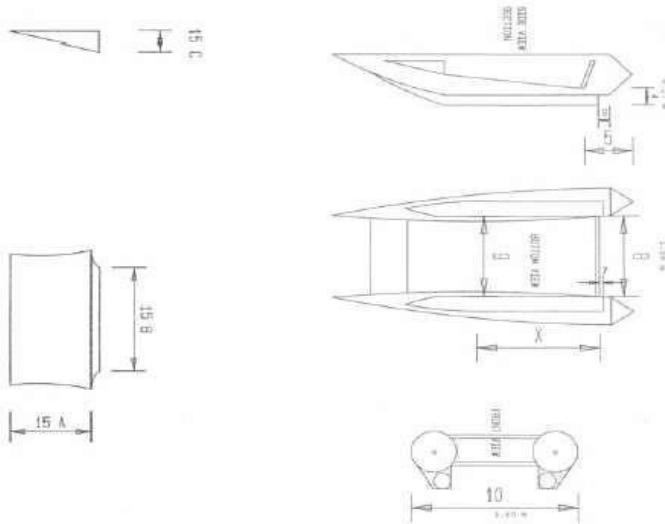

HULL DIAGRAM B:

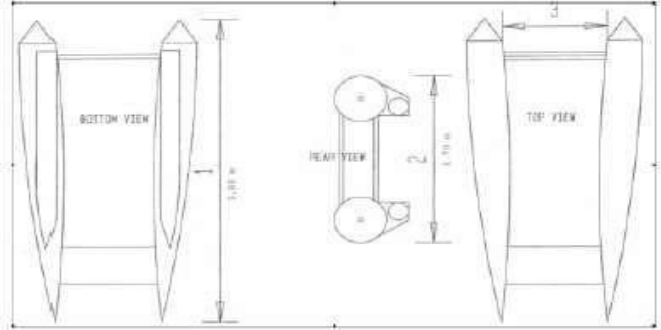

HULL DIAGRAM C:

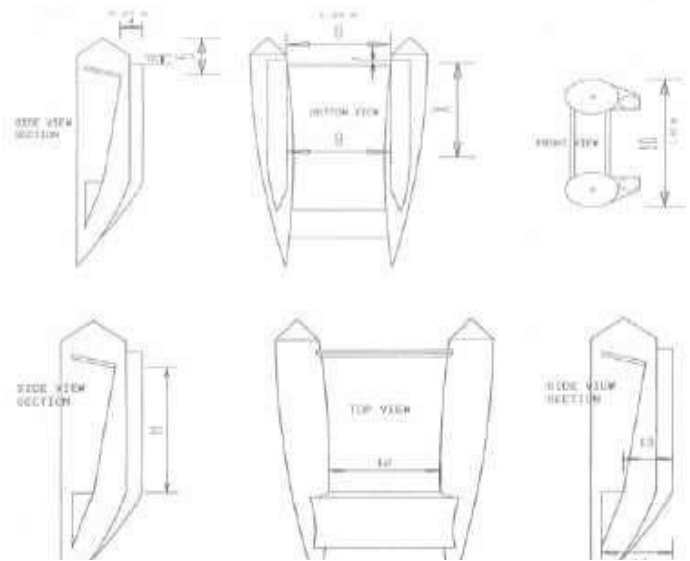

170.020 - INFLATION OF HULLS

They can only be inflated with atmospheric air and must have 3 independent compartments, except for pencil type boats where each pontoon must have 2 independent compartments. The boat must be able to float even if one compartment is not functioning.

170.021 - DEFINITION OF HULLS

All boats should be able to deflate, to collapse, foldable or to be able to be rolled up, so that no dismantled part has a length greater than 1/3 of the full length of the inflated boat including floorboards. No aerodynamic appendages are allowed

170.022 - MODIFICATION ABOVE THE WATERLINE

Certain modifications above the waterline are allowed, these modifications will refer to foot straps, handles, loop patches only and not modifications that interfere with the original dimensions of the boat. A waterline is defined as the line taken when the boat is ready to race but without the Driver/ Co-driver the waterline will be below the bottom of the transom if a multi-hull type. No part of the hull can be used for water ballast.

170.023- SPLASH PLATE

A splash plate may be fitted to the back of the transom as long as it complies with Rule 30.011.05 plus the following dimensions: If this plate runs the full length of the transom, i.e. from pontoon to pontoon, then the width of this plate is restricted to 100 mm. If the width of this plate exceeds 100 mm then its length is restricted to 150 mm across the back of the transom, but may protrude as far back as the engine as required.

170.024- MODIFICATION BELOW THE WATERLINE

Modifications below the waterline: Planing batons and strakes may be attached to the planing surface of the hijackers. Construction spray strakes are permitted anywhere on the outside of the hijacker cover.

170.025 - WINDOWS

Boat numbers can be painted or enclosed in two transparent covers, meeting the correct size and clearly visible.

170.026 - RACE NUMBERS

Must be at the bow of the boat a minimum of 18 cm x 3cm with a 2 cm border round the number and on the engine cover must be 18 cm x 3 cm with a 2 cm border around the number. Their color must be black letters on a white background.

170.027 - RIGHTING ROPES

All boats must be fitted with two designated righting ropes/webbing. These ropes/webbing must not share common use. They must be at least 10 mm thick[rope] and the webbing minimum 25 mm wide. All boats must be fitted with a 4 meter length of similar material as a designated bowline, spliced or stitched eye at the end. The bowline must be fixed to the nose cone in a pouch glued/ fixed to the nosecone. Bowline must not be tied up in other

ropes of the boat and must be easily accessible to be able to hook into the towing point on the bottom side of the nose cone. Towing points must be in the middle of the nosecones. Any towing point must be capable of pulling 300 kg.

170.028 - SPONSORS

The GRP bow of boat must be available for event sponsor's decals; failure will result in not passing scrutineering - requirements must be stated in advance race instructions and stickers supplied by organizers. Cowling stickers may be supplied by the event organizers but must supply with the correct boat number registered and agreed when entering championship.

170.029 - MACHINERY				
No.	RULE	STOCK (S):	PRO STOCK (PRO):	MODIFIED (M):
.1	Engines must be homologated using the UIM specifications. The only outboard engines allowed in these classes are:	1.Tohatsu 50 D2 2.Yamaha 50H per original UIM homologation	1.Tohatsu 50 D2 2.Yamaha 50H per original UIM homologation	1.Tohatsu 50 D2 2. Yamaha 50H Both modified according to the rules.
.2	No other engine will be permitted until the UIM (Cominsport Group) homologate a "low emission" compatible engine for P750 style racing .Introduced min. 3 years after homologation.	YES	YES	YES
.3	Low idle - engines must be capable of functioning at low speeds	YES	YES	YES
.4	Water Pick-up - external water pick-ups wherever/however attached.	Are forbidden	Are forbidden	Free.
.5	Control Handle (Gear) - An efficient control handle giving forward, neutral and backward movement is mandatory. The control handle for a functioning reverse gear must be within easy reach of the driver.	YES	YES	YES
.6	KILL SWITCHES: The manual starter must ensure a quick and easy start with no external aids The engine must be fitted with a "kill switch", operated with a lanyard no longer than 13 meters. The lanyard must be strong and very firmly fixed to the Driver's second "kill switch" lanyard must be firmly attached to the Co-driver at all times. Lanyard /kill switch failure will result in disqualification from the relevant race/ heat or long-haul discipline.	YES	YES	YES

170.030- IRREPAIRABLE DAMAGE/DAMAGED HULL/ENGINE/LOWER UNIT

If a boat, engine, or any part thereof becomes irreparable through a racing incident on the water during a discipline, then: The hull may be replaced. The engine may be replaced. The engine can be re-built. The underwater unit may be replaced. All subject to official inspection and official authorization before any attempt is made on replacement or repairs.

The hull, engine or any part thereof that is damaged beyond repair cannot be replaced during the actual heat being raced Exceptions: An irreparable hull can only be replaced by another if the OOD decides another competitor was responsible for the damage caused only during a race or training on the water. Any damaged part of the engine can be replaced with similar except the cylinder block. Underwater units that are damaged beyond repair can be changed provided they have the same gear ratio and from a similar homologated engine.

All changes must be sanctioned and supervised by the Scrutineer or an appointed official. All damaged parts including hulls must be kept in a secure place for any official inspection or pending possible protests. Any equipment subsequently found to be repairable will result in the driver being eliminated from the complete event. All costs pertaining to the stripping of additional equipment will be the responsibility of the competitor in question. A fee, as specified in the advanced program, must be paid to cover the inspection of any protested engines or equipment. These charges should be reasonable. When different disciplines are held on different days and no fully secure compound is available either overnight or days then all boats must be re-scrutineered before racing re-commences. Failures will result in the loss of all previously gained points.

170.031 - GEARBOX

Gearbox must not be interfered with or modified in Stock and Pro Stock Classes. Any normal wear and tear on the fin/skeg shall be limited to 5mm and must be seen to be racing wear and tear; all fins/skegs will be measured and must comply at Pre Scrutineering of each discipline. If illegal the team will be disqualified if unable to change prior to that heat or Long-haul discipline. A stainless steel cover, with the same characteristics as an original gearbox, can be used to protect the leading edges.

170.032 - MODIFICATIONS				
No.	RULE	STOCK (S):	PRO STOCK (PRO):	MODIFIED (M):
.1	Replacement:	The replacement of nuts or the addition of lock nuts, drilling and wiring, split-pinning or keying is allowed provided the screw and pins are similar.	As per Stock Class	As per Stock Class
.2	Gear interlock	The gear interlock device on the starter may be removed.	As per Stock Class	As per Stock Class
.3	Steering:	The steering bar and brackets may be re-enforced and additional steering bar may be mounted. The steering bars must be able to tilt independently from the motor. Strengthening of transom bracket and lower leg are permitted.	As per Stock Class	As per Stock Class
.4	Engine locking	Engine locking brackets may be removed.	As per Stock Class	As per Stock Class
.5	Engine cowling	The engine cowling may be secured by means other than or in addition to the standard means.	As per Stock Class	May be altered to increase air flow and secured by means other than or in addition to the standard means.
.6	Tell-tale	Tell-tale cooling pipe may be replaced with another pipe or other characteristics.	As per Stock Class	Free
.7	Splash plate	A splash plate may be fixed to the trunk of the motor as long as it is not rigid and that it is fitted above the cavitation plate.	As per Stock Class	As per Stock Class
.8	Crankshaft	The crankshaft may be welded or pinned as long as the dimensions of the crank after welding do not exceed the original manufactures dimensions and weight for crankshaft. Holes maybe drilled in the crankshaft to reduce weight. It is not allowed to reduce the diameter of the crankshaft	As per Stock Class	As per Stock Class
.9	Propellers:	The original propeller maybe replaced by any other three blade propeller; provided that it has a through the hub exhaust. The locking nut, spacer, adaptor, split pin, thrush washer/ washers are free for the securing of the propeller; Re-bushing and keying of propellers are allowed. No holes or ventilation slots of any nature whatsoever are allowed in the hub or blade. No spacing out of propeller to allow venting. Propeller must enter gearbox housing by a minimum of 1mm. Transgression of this rule will lead to disqualification.	As per Stock Class	Free
.10	Re-boring	Re-boring is allowed as per UIM homologation specifications. Parts must be as supplied by the original manufacturer. No aftermarket parts can be fitted. Oversize pistons can be fitted providing the total cc's does not exceed 750cc	As per Stock Class	Allowed up to a max of 750cc
.11	Ports	When ports in cylinders are adjusted to the dimensions specified in the homologation sheet, material may only be removed in the specified opening to a depth of 10mm not including liner, to match the shape of the original adjacent connecting passage (channel) outside the adjusted port opening. This also applies to other openings in the motor for which the dimensions are specified in the homologation sheet. Should the modified port window be smaller than the track, the track may not be tampered with.	As Stock Class	Free
.12	Parts	No part of the engine can be changed with another manufacture's or pirate part, except for the tiller arm. Tiller arm bracket, gear change lever	As per Stock Class	Parts may be changed with another manufacturer
.13	Air box	Maximum of 1 x 6 mm hole may be drilled in the lowest part of the air box to allow water to drain from it.	As per Stock Class	As per Stock Class
.14	Spark plugs	Original complete spark plugs and HT leads may be replaced.	As per Stock Class	As per Stock Class
.15	Auto lube & engine mounts	All auto lube and any relevant parts may be removed. Engine mountings may be replaced with rigid or rubber mounts with similar characteristics.	As per Stock Class	As per Stock Class
.16	Throttle lever	Springs may be added to the throttle lever of the carburetors Tohatsu D1 Throttle cam can be used on the Tohatsu D2 Engine.	As per Stock Class	Free
.17	Emulsion tubes	Emulsion tubes are to be standard "off the shelf" items and have the same pre-requisites as the jets. No modifications are allowed to these parts	As per Stock Class	Free
.18	Baffle plate	Baffle plate or other fuel surge preventative measures can be taken in carburetor fuel bowls.	As per Stock Class	As per Stock Class
.19	Steering	It's allowed to change bearings with similar characteristics. Steering dampers may be fitted. Steering by a tiller arm is required. See Rule 563.3	As per Stock Class	As per Stock Class

.20	Reeds	Standard reeds only as supplied by the manufacturer for the specific model of engine	Reeds only are free. The stoppers must not be removed.	Free
.21	Machining:	Skimming, grinding or machining is allowed as long as it meets the UIM homologation measurements.	As per Stock Class	Free
.22	Starters:	Electric starters are not allowed.	As per Stock Class	As per Stock Class
.23	Thermostats:	Thermostats of the cooling circuit may not be removed.	As per Stock Class	Free
.24	Revolution limiters:	Rev Limiters, heat sensors and lighting coils must not be removed. Rev limiter wire connections must be continuous and must be soldered to achieve this. Anything that might restrict the rev limiter in its proper function will be classed as an infringement of this rule. Ignorance of the above will not be accepted as a defense and the competitor will be disqualified.	Can be removed	Can be removed
.25	Jets:	Jets have to be to the UIM homologation specification.	Free	Free
.26	Weight of part:	A part, the weight of which is quoted in the homologation sheet, may be machined for the specific purpose of reaching the quoted weight only. It is not allowed to change the flywheel, but balance machining is allowed if the dimensions and weights are still correct	As per Stock Class	No restriction on weights quoted
.27	Measurements:	Measurements not quoted in the homologation sheet may not be altered in any form whatsoever. If details cannot be verified with the aid of the pictures in the homologation sheet, then the part in question must be compared physically to a similar, but stock part for the relevant engine. For the Tohatsu D2engine exhaust port only: There is a casting mark on the inside of the engine exhaust port that does vary in size from engine to engine. This casting mark can be reduced no less than 0.5mm this will be considered to be a breach of the technical rules and can be disqualified.	As per Stock Class	Measurements not quoted in the homologation sheet may be altered
.28	Altering parts:	Only parts where the dimension is quoted in the homologation specification may be altered for the purpose of reaching that specific measurement. The shape of the parts cannot change e.g. The shape of the cylinder head squish pan} The Block height measured from the centre line to the top of the block is allowed, all measurements according to UIM homologation papers	As per Stock Class	Parts may be changed by another manufacture
.29	Kill Switch:	It is not allowed to exchange kill switches from one manufacturer to another. The toggle type switch that can be activated without the insertion of the "curly cord" is forbidden	As per Stock Class	It is allowed to exchange kill switches from one manufacturer to another. However, the toggle type switch that can be activated without the insertion of the "curly cord" is forbidden
.30	Exhaust trunk	No modifications	As per Stock Class	Holes may be drilled or cut into the exhaust trunk but no external appendages may be added
.31	Gear Box	See rule: 562.08	See rule:562.08	Bullet or racing gearboxes are allowed in this class only.
.32	Protrusions	No protrusions other than standard are allowed.	As per Stock Class	As per Stock Class
.33	Exhaust box	No protruding expansion exhaust box	As per Stock Class	As per Stock Class
.34	External water pick-up	Not allowed	As per Stock Class	Are allowed

170.033- FUEL

Stock and Pro Stock Class: Fuel must be a commercially available grade of automobile 'unleaded' fuel to a maximum of 99 octane, freely available from any normal petrol station. To maximize the equality of competition and to simplify the checking of conformity, the organizers must arrange the supply of the same fuel for all competitors at all UIM titled events. It does not necessarily have to be free of charge.

Modified Class: Only fuel to a maximum of 102 octanes is allowed. This includes Avgas.

Banned Fuel: Special racing fuels, methanol, nitro-methane and the likes thereof are expressly forbidden. The use of additives aimed at increasing the power of the engine is prohibited to either the fuel or the air intake. The use of nitrous oxide injection is also totally prohibited.

170.034 - FUEL DETAILS AVAILABLE:

The Driver/Co-Driver may not withhold the type of fuel/oil used if requested by race officials.

170.035 - OIL

A sample sealed container of the oil used, will be supplied by the competitor with unbroken seal, and then held by the organizers for the duration of

the event in the event of fuel tests. It is a recommendation that Bio-degradable oil should be used to assist in the reduction of the environmental impact of the sport. No power enhancing oil is allowed.

170.036- FUEL TANKS

Only the original fuel tanks as supplied with the engine, collapsible fuel cells or approved marine manufacturers tanks are allowed.

170.037 - FUEL MIX

No Driver/Co-Driver may withhold the type of fuel/oil used and the mixing ratio if requested by officials.

170.038 - TECHNICAL				
No.	RULE	STOCK (S):	PRO STOCK (PRO):	MODIFIED (M):
.1	Pistons	Where a dimension is quoted on a piston, metal may be removed to reach a specific weight, provided the dimensions are maintained. Should there still be excess weight, this may be removed from the inside of the piston i.e. the inside of the skirt or the area where the gudgeoned pin goes through	As per Stock Class	N/A
.2	Flywheel	It is not allowed to reduce the outside diameter or to change the flywheel. Weight reduction can only be done by drilling holes in the starter gear ring, only by a maximum of 8mm diameter and maximum depth of 4mm per hole. Balance machining by drilling holes in the area stated is allowed if the dimensions and weights are correct as per UIM homologation.	As per Stock Class	Allowed to remove starter ring
.3	Conrods	It is allowed to reduce the overall weight of the Conrods by removing the flashing on the shank of all three rods to attain the weight specified provided for in the homologation specifications	As per Stock Class	As per Stock Class
.4	Electrical components	It is forbidden to remove any excess wiring; heat sensors modify coils, to rewire coils or other components, to tamper with CDI units or to add any electrical components (starter etc.) or any other part that is not standard original part.	It is allowed to remove any excess wiring i.e. heat sensors, rev limiters, low oil sensors etc. It is forbidden to modify coils, to rewire coils or other components, to tamper with CDI units or to add any electrical components (starteretc.) or any other part that is not standard original part.	As per Stock Class
.5	Head Volume	It is allowed to encroach into the squish pan area in the skimming process as long as the minimum combustion chamber is maintained. It is not allowed, should this minimum be exceeded, to remove the metal within the squish pan area to regain the lost volume. Measurement of the head volume will be taken with the head removed from the block.	As per Stock Class	No restrictions
.6	Head Volume Measuring procedure and modification of engine Ports	The head volume is measured off the block, using a glass plate of minimum 3 mm thick. A burette calibrated in 50 cc increments to be used with a paraffin/oil mix of 50/50. All head volumes to be taken with the spark Plug as used and correctly fitted. The head is measured with no gasket. All old gasket material is allowed to be cleaned off. It is also allowed to clean all carbon deposits in the head. The glass plate must be sealed with a thin layer of marine grease. When ports in cylinders are adjusted to the dimensions specified in the homologation sheet, material may only be removed in the specified opening to a depth of 10mm not including liner, to match the shape of the original adjacent connecting passage (channel) outside the adjusted port opening. Should the modified port window be smaller than the track, the track may not be tampered with.	As per Stock Class	No restrictions
.7	Throttle advance	On various models, it is allowed to change the position of the throttle cable link pin on the advance cam. It is not allowed to modify the cam itself or change the radius on the cam. [See 563.16.]	As per Stock Class	Free
.8	Cost of inspection	Costs may not be claimed in the case of a mandatory inspection by race authority. The maximum costs that may be claimed, by a driver from a protestor, should the equipment found to be legal, are as follows: LA-BOUR: Time may only be claimed to a maximum of six hours at a rate to be determined by their local class association or National Authority. Any excess will be borne by the owner of the equipment. The above cost excludes the cost of gaskets required or lubes which may only be changed as per the recommended grade in the workshop manual. Freight charges, where applicable, will be charged as per the standard international rates.	As per Stock Class	As per Stock Class

.9	Technical inspections	The O.O.D. or official scrutineer will be in charge. Only the following may attend the post-race engine inspections regardless of a protest being lodged. The O.O.D - UIM commissioner - Measuring Officer - Driver and his mechanic (or representative) - Protestor or his representative - Any other person the O.O.D. requires, with his permission. Note that in the case of a protest, the protestor's duty is to ensure that the inspection complies with his protest requirements. He may not however physically inspect the parts himself and should not be allowed within a 5m radius of the equipment.	As per Stock Class	As per Stock Class
.10	Standard Part	In the circumstances where weights and measurements are not quoted nor listed in the homologation sheets then comparative parts maybe used to determine legality.	As per Stock Class	As per Stock Class
.11	Fuel	See fuel regulations 170.033-34. Rule 170.035 Oil to be supplied by competitor unless otherwise specified	As per Stock Class	To a max of 102 octanes is allowed; this includes AV Gas.
.12	Over blended or spark eroded engines	Engines not conforming to UIM and manufacturers homologation specification with regard to the blend rule and that have had tract widening done by any method inclusive of spark eroding, will only be allowed to compete in the modified class.	As per Stock Class	As per Stock Class
.13	Post-race inspection	The post-race inspection is to be a complete inspection and is not to be limited to any specific area. Post-race inspection should mainly be about speed and power enhancing matters.	As per Stock Class	As per Stock Class
.14	Failure to appear	Any competitor refusing to have his racing equipment inspected for legality at any reasonable time during the whole event will be disqualified.	As per Stock Class	As per Stock Class
.15	Non OEM parts	In the case where original parts are not available, permission must be obtained from the UIM Cominsport to use substitute components. Such a request must be in writing. Any outboard motors that have superseded engine parts listed by the manufacture, supplied from the factory and confirmed in writing by the UIM Cominsport may be used. It is not allowed to interchange parts from one homologated model to another unless specified. Only D2 parts can be used in a Tohatsu D2 engine except for the D1 throttle cam.	As per Stock Class but for the Tohatsu D2 engine the D1 exhaust tube may be used in this class.	Parts may be changed with another manufacturer.

170.039 - RACING REGULATIONS AND RULES

No.	Rule	The M 'Shape (Surf)	Circuit	Long-haul
.1	Race Course:	Shown diagrammatically in diagram D as a guide only. Starts for this discipline should be Beach Wet Start or Beach Le Mans. Note 1: Any form of start procedure listed as per the P750 rules may be used and the start procedure that is most suited to the current conditions should be used. Note 2: There does not have to be breaking Surf in order to engage in this discipline, although it should take place on a suitable beach where possible. If the water conditions are flat then the O.O.D should brief the drivers to maintain their lanes and may decide to add a 1A mark further out for the start lap only to enable a longer start run.	Diagram E. This is a guide only, the course can change shape due to the size of the water available. Course size should be shown in the advance race instructions. Starts for this discipline should be flag or jetty start from pontoon or beach. Note 1: Any form of start procedure listed as per the P750 rules may be used and the start procedure that is most suited to the current conditions should be used.	Should be run over a maximum distance of 150kms to a minimum of 80kms. Minimum lap distance of 10kms and should be area bound. The organisers must provide a boat/s prior to the race to show teams the course by water, explaining any safety issues. This event can be staged in two legs in one day or over two days, having individual legs of a minimum of 60kms per leg and a maximum of 150kms in total, it must be stated in the advance program. <u>Ultra Long-haul:</u> Over 150kms. The organisers will provide an extended list of extra rules for the event, including race regulations that should be read in conjunction with the UIM Rules in the advance programme. This event can be staged over several days having individual legs. Starts for this discipline can be any form of start procedure listed per the P750 Rules.
.2	Wet Driver: (man overboard)	If any Driver or Co-driver lands completely in the water or a boat gets stuck on the beach during racing, the race will be stopped immediately, even before the red flag is flown. All competitors must stop, then come off the plane, clear the course and proceed to the start line with extreme caution or as stated in Drivers Briefing. No re-fuelling, or changing set-up and get ready for an immediate re-run. The boat causing the stoppage is not allowed in any re-runs of that heat. Penalties are carried forward to any re-run/start of that heat. Any boat that gets stuck on the beach may only re-start with the OOD's permission If more than 2/3 of the race or re-start/run race has been completed then no re-run is required. Restart can be from the beach or deep water start.	As per Surf except all restarts and re runs take place from the jetty/pontoon or beach and rule 170.040 (Re-Run)	Only if required by the OOD the Red Flag will be raised; the race will not stop if someone goes into the water in this discipline.

.3	Racing buoys	If a competitor misses or rides over a buoy and crosses the racing line on the inside of the course, he will be disqualified from that heat at the OOD's discretion	As per Surf.	Deviation of the set course markers will result in disqualifications.
.4	Additional Penalties	The O.O.D must state at Drivers Briefing if there are any additional penalties that could occur on or off the water due to Force Majeure under the grounds of safety.	As per Surf.	As per Surf.
.5	Missing Buoys / deviation from the course.	If a Driver misses a buoy, he can re-take it if he has not crossed the racing line on the inside of the course. The boat in question does not have the right of way when re-entering the race course and must give-way to any competitor already on the correct course.	As per Surf.	Deviation of the set course markers will result in disqualifications.
.6	Damaging buoys	If a competitor destroys or damages a buoy and causes the race to be red flagged he will be disqualified from that heat and any restart of that heat. The competitor must pay the organiser the cost of a replacement buoy which sum must be in the advance programme. If not in the advance programme then the competitor can refuse to pay. If a competitor damages a buoy but the race is not red flagged, he will be deducted 3 points and the competitor must pay the organiser the cost of a replacement buoy and tackle, which sum must be in the advance programme.	As per Surf.	As per Surf.
.7	Bumping	<u>Deliberate</u> bumping of another competitor is strictly forbidden and will result in the disqualification from that heat or re-start/re-run and possible disqualification from the whole discipline if seen by the O.O.D as reckless and dangerous driving. Other UIM penalties may also be given.	As per Surf.	As per Surf.
.8	Crashing	If one boat lands on another, the offending boat or boats will be disqualified from that heat/race.	As per Surf.	As per Surf.
.9	Close Driving Tail-Gating, Zigzagging or Snaking	The O.O.D may enforce penalties including disqualification and or Yellow / Red Cards for the following infringements: 1. A boat that follows dangerously close or directly behind (tail-gating) 2. A boat that is snaking in front of another boat or repeatedly changing lanes in front of another competitor. If the competitor repeatedly offends during the discipline the O.O.D can disqualify the team from that discipline.	As per Surf.	As per Surf.
.10	T Bone	If any boat collides mid-ship with another (T-Bone) the offending boat will result in immediate disqualification from that heat / race. Other UIM penalties may also be given.	As per Surf.	As per Surf.
.11	Shore Buoys	There should be a minimum of 10 meters between the shore buoys and the shore with sufficient water depth to race approximately 0.5m. This must also be evaluated in the Event risk assessment.	As per Surf.	As per Surf.
.12	Race distance/ laps	All heats should include a start lap plus 6 laps and the final will be a start lap plus 9 laps for all classes unless stated otherwise in the Advance Race Instructions or at the O.O.D / Race Committees discretion due to weather conditions. In the case of force majeure laps, race distance & heats may be altered by the O.O.D. Every effort should be made to implement the required amount of laps as per the rules. STOPPING A HEAT AND NOT HAVING A RE-RUN: If the heat has to be curtailed and more than 2/3rd of the heat has been completed (full laps rounded up / distance covered) then a result can be posted.	As per Surf. Equalizing laps: A 6 lap heat includes a start lap plus one equalizing lap and the 9 lap final includes a start lap plus 2 equalizing laps. In the case of force majeure, race distance and heats may be altered by the OOD. Every effort should be made to implement the required amount of laps as per the rules. STOPPING A HEAT AND NOT HAVING A RE-RUN: If the heat has to be curtailed and more than 2/3rd of the heat has been completed (full laps rounded up / distance covered) then a result can be posted. In the Circuit discipline all boats must have completed their equaliser laps.	Rule 170.040.1 Long-haul STOPPING A RACE AND NOT HAVING A RE-RUN: If the race has to be curtailed and more than 2/3rd of the race has been completed (full laps rounded up / distance covered) then a result can be posted.

.13	Race Finish / Time Allowance.	The race finishes when the lead (1st Place) boat crosses the finishing line. Any boat that has not completed 2/3rds of the race (full laps rounded up) when the winner crosses the finishing line will not score any points for that heat. All boats must cross the finish line on the water either by their own power or paddle power to be classified and eligible for points. Boats must proceed around the buoy beyond the start /finish line to the designated muster area as described at drivers briefing and wait for the red flag to be shown from the shore as the signal to return. Drivers failing to do this can be penalised or disqualified by the O.O.D.	As per Surf.	A boat must cross the finish line on the water, under its own power, or by paddle power, to receive an elapsed time / position for the leg / race. The cut-off time for the last competitor to cross the line is 1.5 x the first boat's time in that specific class or as per Drivers Briefing. Once a boat has crossed the finish line, it may not cross back and re-enter the race/leg until the finish line is officially closed. Re-entering will result in disqualification. All safety procedures will be kept in place until all boats are accounted for.
.14	Minimum & Maximum number of boats	There will be minimum 3 and maximum 12 boats to make a race. In the event of the entry exceeding 12 boats, then eliminating heats will be run as per rule 170.040.1 .	As per Surf.	There is no maximum; but the evaluation for safety must be in the event risk assessment.
.15	Awarding Final points	1. The total points for the qualifying heats plus the final heat (double points) of the top 12 boats will be added together to determine the overall 1 st - 12 th positions; then converted to single points for that discipline as per Rule: 170.040.21 2. The remainder of the fleet will be awarded points as per their positions after the qualifying heats. 13 th Place will receive 3 points, 14 th Place - 2 points, then 15 th Place and the remainder of the finishers will all receive 1 point as per Rule: 170.040.2	As per Surf.	Single points are awarded as per Rule: 170.040.2
.16	Burst hull or helmet loss	If a boat should burst or deflate rapidly during a race for any reason, that driver must cease racing, remove the boat from the race course and continue to shore in a safe manner. If a Driver or Co-Driver loses his helmet, they must immediately stop racing; a red flag will be shown and the boat in question will be disqualified from the heat. Further penalties may be invoked if enquiries lead to a failure due to any error by the person incurring the loss.	As per Surf.	If a boat should burst or deflate rapidly during a race for any reason, that driver must cease racing, remove the boat from the race course and continue to shore in a safe manner or call for immediate assistance from the safety fleet. The boat in question will be disqualified from the race or leg. If a Driver or Co-Driver loses his helmet, they must immediately stop racing and remove the boat from the race course and continue to shore in a safe manner or go to a safety boat for assistance. The boat in question will be disqualified from the race or leg. Further penalties may be invoked if enquiries lead to a failure due to any error by the person incurring the loss.
.17	Flags	All flag signals except the green flag will conform to the UIM Rule 304.02. National authorities may have exceptions but must notify teams at Drivers Briefing and in the Advance Race Instructions.	As per Surf. P750 use the Yellow and Green Flags for starting the Circuit class	As per Surf, but no 'last lap' flag is used if not a circuit long-haul.
.18	Flag acknowledgement	All competitors must acknowledge all flag signals to the official giving the signal, unless stated in Drivers Briefing by the O.O.D. Failure may lead to the loss of 2 points at the discretion of the O.O.D.	As per Surf. All competitors must acknowledge all flag signals to the official giving the signal, unless stated in Drivers Briefing by the O.O.D. Failure may lead to the loss of 2 points at the discretion of the OOD.	As per Surf.

.19	Race Starts	As per Rule: 170.041	As per Rule: 170.040.5 . On a restart the boats must go back to original starting grid positions of that heat as not every boat may have completed their equaliser laps.	As per Rule: 170.041.2
.20	Race Live	The race will be live when the green flag drops. The heat is live when the last running boat crosses the start/finish line for the first time. If the last boat has not passed the start/finish line, then the re-start is for the full amount of laps with no re-fuelling or changing set-ups.	As per Surf.	The race will be live (Start) when the Green flag drops.
.21	Race finish	The race finishes when the lead/1 st boat crosses the finishing line. (Checked flag). Boats must go to the designated Finishing Muster area as described in Drivers Briefing. Drivers failing to do this can be penalized or disqualified by the O.O.D. Boats that have not completed 2/3rd of the race (full laps rounded up) when the winner crosses the finish line will not score any points for that heat. All boats must cross the finishing line (checked flag) to be awarded points.	As per Surf.	A boat must cross the finish line under power or by paddle to be awarded points. Once a boat has crossed the finish line, it may not cross back and re-enter the race/leg until the finish line is officially closed. Re-entering will result in disqualification.
.22	Safety equipment	Paddles x 2 Designated righting rope/webbing x 2 Designated Bowline. Kill switches x 2	As per Surf.	Rule: 170.040.3
.23	Eliminating heats	START POSITIONS M Shape (Surf) To select pole/grid positions and a draw is required, it must take place at Drivers Briefing in front of the Teams. See rule 170.040.1	As per Surf.	As per Surf.

.24	Laps	All equalizing heats will have be a start lap plus 9 laps 6 laps and a start lap plus 9 laps for the Final heat for all classes unless stated in the Advance Race Instructions or at the O.O.D / Race Committees discretion See Rule 170.039.12	As per Surf. If a Start / restart / re-run is required of 6 or 4 laps only 1 equalizer lap is required. 9 lap final will have 2 equalizing laps included. See Rule 170.039.12	Not applicable. See Rule 170.039.12
.25	Outside assistance	No person shall provide or receive outside assistance from the air, water or by radio during the race. There shall be no outside assistance allowed in a re-run / re- start unless the O.O.D has allowed an assistant to hold boats on the start. If an engine has not fired on the start line then original crew assistance may be given providing that the O.O.D has allowed an assistant on the original start. If the crew or boat are deemed to be at risk at any-time then the O.O.D may order them to withdraw from the start line. Failure to observe this rule will result in disqualification from the race.	As per Surf.	As per Surf. A handheld GPS can be used
.26	Definition of a 'Race'	When the green flag is dropped and the chequered flag is raised, Rules 170.041.20-21	As per Surf	As per Surf
.27	Definition of a 'Heat'	Part of a number of races that provide an elimination process to get to the Final race of either the circuit or surf disciplines	As per Surf	Not applicable
.28	Definition of a 'Leg'	Not applicable	Not applicable	A Leg be part of a Long-haul, if the discipline is divided into sections or staged over a period of days.
.29	Definition of a 'Group'	Group: When there are more than 12 boats in a class, the class must be split into groups for the eliminating heats.	As per Surf	Not applicable

170.040 - GENERAL RACING RULES:

170.040.1 GRID POSITIONS FOR INTERNATIONAL EVENTS AND FINAL CHAMPIONSHIP POINTS

The first heat of any UIM championship has to be authorized by the organizers. At all UIM titled events the following will apply.

1. The grid positions for the first heat / race or leg (Ultra Long-haul) of which ever discipline is run first will allocate pole position to the previous equivalent Championship overall winner if they are competing within the event. (Example World Champion takes pole position). All other Drivers will have their positions draw by a random method (out of a hat) at Drivers Briefing in front of the teams.
2. If there are more than 12 boats in a class, the teams will be divided into groups; the teams should be evenly split (where possible) into

groups irrespective of nationality. E.g. Position 1 into Group 1 - Position 2 into Group 2 - Position 3 into Group 1 etc. following the same allocation process until all teams placed. In the case of no previous championship placing's being available the groups will be determined using race numbers to draw their positions.

3. Only the Driver's names are taken into account when forming the grid positions ny Co-Drivers names are discounted. After the first discipline has been completed the second and third disciplines initial pole position will be decided by the previous discipline's overall results.
4. The grid positions for the second heat in that discipline will be as they finish in the first heat. The grid positions for the final heat will be the aggregate positions (points) of the previous heats of that discipline.
5. In the case of equal points (tie) for the final grid positions, the highest heat positions will be used (amount of 1st, 2nd, and 3rd respective). If there is still a tie, then a draw between the tied positions will take place in front of the relevant teams by the O.O.D.
6. Final Championship points: In the event of a tie in the points then the highest placed result in all three discipline finals will be used

170.040.2 POINTS & GUIDELINE TO ELIMINATING HEATS:

In the event of there being more than 12 boats entered in the same class eliminating heats will be run in the M Shape (Surf) and Circuit discipline. In the Long-haul discipline single points will be used as all boats race together.

POINTS:

SINGLE POINTS

1st	20	5th	11	9th	7	13th	3
2 nd	17	6th	10	10th	6	14th	2
3rd	15	7th	9	11th	5	15th	1
4th	13	8th	8	12th	4	PLUS 15th	1

Guideline for eliminating heats for more than 12 in a class.

1. Each 'Group' must race a minimum of 2 heats
2. Each 'Team' should be in 2 groups per day.
3. Each 'Team' therefore races a minimum of 4 heats and the top 12 boats in the class will race in the final
4. At Drivers Briefing all teams will be randomly drawn and put into groups for the morning and then redrawn for the afternoon heats.
5. The winning team in each class from the previous discipline/equivalent championship will take pole position in their group for the first morning heat. The afternoon groups will use their grid positions that were randomly drawn at Drivers Briefing.
6. After each heat the points will be added to a team's individual running total during the day
7. After the last heat the points will be added together and go towards their overall results and will confirm the top 12 positions who will compete in the final race. The final race is for double points, their points added to their existing heat points to confirm the overall positions from 1st - 12th place; then worked back at the end of the discipline to single points.
8. All other teams below 12th place will take single points thereafter, to give overall final results.

HEATS: START LAP PLUS 6 LAPS FOR CIRCUIT AND M SHAPE (SURF) DISCIPLINES.									START / 9
MORNING	Heat 1	Heat 2	Heat 3	BREAK	AFTERNOON	Heat 4	Heat 5	Heat 6	FINAL
GROUP A	1	2	3						
					GROUP Y	4	5	6	THE TOP
GROUP B	1	2	3						12 BOATS
					GROUP Z	4	5	6	OVERALL

170.040.3 - DANGEROUS DRIVING

Dangerous or reckless driving will lead to disqualification from that heat or discipline. Intentionally causing damage to another boat or bodily harm to a competitor will result in disqualification from that discipline or the whole event at the OOD's discretion Further penalties may be applied.

170.040.4 - OVERLAP

1. If overtaking on the inside an overlap is only established when two boats are approximately on the same course, and the boats are parallel to each other.
2. When overtaking from the outside an overlap is established when the overtaking boat has passed the overtaken boat sufficiently to change direction without contact.
3. The lead boat has the right of way until an overlap is established.
4. A safe overlap is the responsibility of the overtaking boat.
5. An overlap can occur from left or right.
6. An overlap may not be established on the inside of the actual race course.

DIAGRAM D:

OOD Territory - The area in which a race boat can cross but loses its 'right of way' to other racers (must give way in this area).

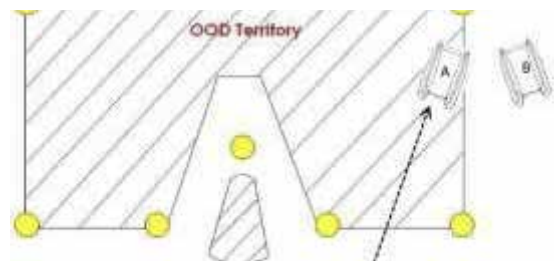

The boat (A) inside the racing line may go into the OOD Territory but they loose their right of way to return onto the course and must give way to oncoming boats (B).

DIAGRAM E: Over-Taking

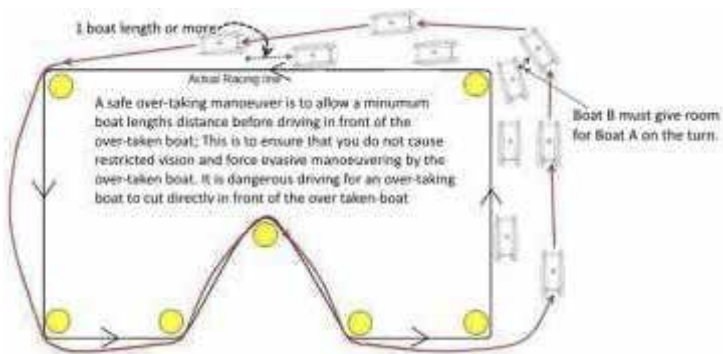
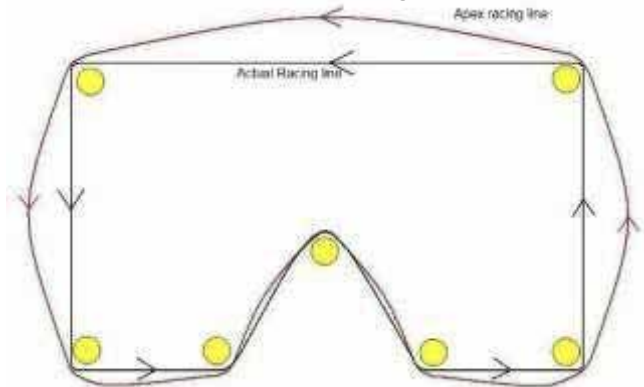

DIAGRAM F: Racing Lines



170.040.5 - OVERTAKING

An overtaking boat shall keep clear of the boat that is being overtaken.

170.040.6 - PASSING MARKS

When trying to overtake a boat on the inside, the driver must anticipate the possible direction of the boat he is trying to overtake and must take all necessary action to avoid a collision.

1. When passing a turn buoy and an overlap has been established, both boats must maintain a safe distance from each other and from the turn buoy.
2. Once an overlap has been established the overtaking boat must give the overtaken boat room to clear any course markers.

170.041 - M SHAPE / SURF DISCIPLINE

170.040.1 START M SHAPE (SURF)

The Race is-6 laps plus a start lap. The start will be explained at Drivers Briefing and will be as follows:

Option 1: BEACH WET START

1. Both Driver and Co-Driver will be out of their boat.
2. The kill switch plugged in and the engine off.
3. Both hands of the Driver and Co-Driver must be on the anti-hogging rope.
4. Both feet of the Driver and Co-Driver must remain on the ground at all times up to the green flag dropping.
5. On the drop of the starter's green flag, the race will start.
6. The Driver and Co-Driver must have both feet on the floorboard of their boat before the driver can start his engine.
7. Failure to abide by any of these rules will result in a 2 point penalty deducted and being moved to the end of the grid.
8. In the event of a boat not starting, the boat must withdraw from the water before the lead boat of the starting boats complete a full lap.
9. Due to surf conditions, the start may be changed during the discipline after consultation between the O.O.D. and the Rescue Officer.

Option 2: BEACH LE MANS

At the discretion of the O.O.D Le Mans starts maybe used whilst racing from the beach. This will depend on weather conditions and will be notified at Driver's briefing.

1. Boats must be held in a line on the water by either the Driver or the Co-Driver.
2. The boats must be at least 2 meters apart.
3. The Drivers / Co-Drivers should be lined up in such a way that they run an equal distance to their boats.
4. Kill cords must be held at full arm's length in the air by the Driver.
5. The Driver cannot start the engine until the Co-Driver is in the boat.
6. The Co-Driver cannot start the motor.
7. Motors can be started in or out of gear.
8. Any team jumping the start by starting their engine before the Co-Driver is in the boat and does not have their feet on the floorboards will be moved to the end of the grid and given a 2 point penalty.
9. A boat handler is permitted to assist with the holding of the boat in difficult conditions at the O.O.D discretions.
10. In the event of a boat not starting the boat must withdraw from the water before the lead boat of the starting boats complete a full lap.
11. The team can be disqualified if the assistant is still in the water when the first of the leading boats rounds the start/finish buoy for the first time.

Option 3: DEEP WATER STARTS

1. Muster area will be defined either in race instructions or explained at the Drivers Briefing.
2. Two minutes before the start of the race the start boat will raise and continue to display a 'Yellow Flag'
3. The boats must proceed to line up side by side.
4. The start boat will then proceed across in front of the fleet and then returns back across the front of the fleet.
5. When the Start boat has crossed the fleet for the second time it will turn to face the racing line.
6. At the start the boats must keep 20m behind.
7. The yellow flag will go down and the green raised. This will indicate the start of the race.

170.040.2 START LINE

Any Driver not on the start line when the green flag is raised may not start that heat or any re-start of that heat. Any Driver that fails to start when the green flag is dropped may only enter the racecourse when it is safe to do so. This is only allowed if the leading boat has not completed one lap. One back-up crew per team is allowed to assist at the start provided he is positioned opposite the-Driver at the start with the OOD's permission. Only Drivers that were on the start line and failed to start can take part in any re-start of that heat. Any-Driver or Co-driver jumping the start either by starting

his engine early or not observing their feet on the floorboard rule, will receive a two point penalty deducted and be moved to the lower end of the grid. A second offence will mean disqualification from that heat.

170.040.3 RESTARTS (SEE ALSO WET DRIVER RULE)

Definitions: Re-start refers to re starting the race prior to the heat going live and goes back to the original starting grid of that heat. Re-run is once the heat has gone live.

1. Re-start refers to re starting the race as the red flag has been raised before the last boat has passed the start/finish line.
2. The re start goes back to the original starting grid of that heat including the start lap.
3. Any accumulative penalties will be carried over into any Re-start.
4. No re-fuelling, or changing set-up and propellers can take place on a re-run or re-start.
5. Boats that are on the starting grid when the green flag drops can join a re-start.

170.040.4 RE-RUN

Re-run: Once the heat has gone live.

1. Re-run of a heat/final can take place from the beach or in deep water.
2. Deep water Re-Run: will be done with a pace boat.
 - a) All boats must muster at the area of buoy 1 - see diagram G.
 - b) A green flag will be used to start the re-run from the pace boat.
 - c) All boats must keep their positions as per the previous lap and follow each other closely.
 - d) Boats are not allowed to overtake or change positions until the green flag is dropped.
 - e) Any Driver changing positions during the run up to the starter or when under starter's orders will be given a deduction of a 2 (two) point penalty
 - f) On a deep water start the chicane is missed out, unless otherwise directed at Drivers Briefing from the OOD.
3. Beach Re-Run: if the water conditions allow, using a green flag to start. All boats must keep their grid positions as per the previous lap. The procedure will be the same as a standard start but without the start lap.
4. The officials will monitor grid positions prior to the re-run.
5. Any accumulative penalties will be carried over into any Re-starts / Re-runs.
6. Laps will be reduced from 9 to 6 to 4 to 2 respectively, unless the OOD reduces laps on the grounds of safety.
7. No re-fuelling, or changing set-up and propellers can take place on a re-run or re-start.
8. Boats that do not start the race cannot join a re-run.

170.040.5 - CIRCUIT DISCIPLINE

170.040.1 START: CIRCUIT

The race is 6 (Six) laps plus a start lap (part of the long lap), followed by a short lap which is the first of the 6 (Six) laps, you cannot use either of these laps, nor the last lap as an equalizing lap. The start, all s Drivers must keep their line, maintaining their lane to and through the first turn. Drivers must not change lanes in front or behind other Drivers until they have passed and rounded the first buoy, or they will receive 2 (two) penalty points or be disqualified from that heat at by the O.O.D.

170.040.2 FLAG OR JETTY START FROM PONTOON. CIRCUIT

Starts will utilize two flags system with both s Drivers and Co-s Drivers in their boats. Both flags are raised and on dropping the first flag, the engine can be started in neutral. On dropping the second flag, forward gear may be engaged and the race starts ll drivers must complete a "part of a long lap" as the start lap, followed by a short lap as the first of the 6 (six) lap heats or 9 (nine) lap final. This does not count as one of the compulsory equaliser laps. If a boat jumps the start for the first time, a two point penalty deduction will be given and moves to the end of the pontoon. If the same boat jumps the start again, they will be disqualified from that heat. If another different boat also jumps the start after a previous jumped start, that boat will then be moved to the end of the grid next to the first offender.

170.040.3 EQUALIZER LAPS

Each driver must complete

1. A 6 lap heat - 1 lap of the equalizer circuit must be taken between lap 2 and 5 - Failure to do the equalizing lap will result in disqualification from that heat.
2. A 9 Lap Final heat - 2 laps of the equalizer circuit between lap 2 and 8. Failure to do 2 equalizing laps will result in disqualification from that heat.
3. Equalizer laps must be completed after the first lap and before the start of the final lap. If the equalizer lap are taken on the 1st or last lap a 3-point penalty will apply.
4. If the laps are reduced to 6 or 4 only 1 equalizing lap is required.
5. Boats taking extra equalizer laps within the permitted laps will not be penalized.

170.040.4 RESTARTS

Return to the Start line and resume the original grid positions for a restart procedure unless

1. Re-start refers to re starting the race as the red flag has been raised before the last boat has passed the start/finish line.
2. The re start goes back to the original starting grid of that heat including the start lap.
3. Any accumulative penalties will be carried over into any Re-start.
4. No re-fuelling, or changing set-up and propellers can take place on a re-run or re-start.
5. Only the boats that are on the starting grid when the green flag drops can join a re-start. The boat causing the stoppage doesn't score or go into any restart.

170.040.5 RE-RUN

Return to the Start line and resume the original grid positions for a restart procedure unless, If more than 2/3 of the race has been completed (full laps

rounded up) and all boats have completed LL their equalizer laps, by all the boats running, there will be no Re-run and the results will be taken in the order that the boats last passed the finishing buoy/line The boat causing the stoppage doesn't score or go into any re-run.

170.040.6 COURSE/RACING LINES

The main circuit course and the equalizer lap is specifically detailed in diagram H. Boats deviating from the set course / Lap by taking the wrong turn mark will be disqualified and other UIM penalties may apply if considered a dangerous maneuver.

170.041 - LONG-HAUL DISCIPLINE

170.041.1 TIMES

All Long-haul events will be run on timing.

170.041.2 LONG-HAUL STARTS

Dependent on the discipline (Inland, Offshore or Ultra) the start procedure can be Surf, Circuit or Deep water starts. This needs to be clarified by the O.O.D at Drivers Briefing.

170.041.3 DEEP WATER STARTS

1. Muster area will be defined either in race instructions or explained at the Drivers Briefing.
2. Two minutes before the start of the race the start boat will raise and continue to display a 'Yellow Flag'
3. The boats must proceed to line up side by side.
4. The start boat will then proceed across in front of the fleet and then returns back across the front of the fleet.
5. When the Start boat has crossed the fleet for the second time it will turn to face the racing line.
6. At the start the boats must keep 20m behind.
7. The yellow flag will go down and the green raised. This will indicate the start of the race.

170.041.4 SAFETY EQUIPMENT

In a Long-haul event the following safety equipment is the minimum requirement and must be carried at all times. All equipment should be clearly marked with the boat number. The advance race instructions must state what equipment is required dependent on the type of Long-haul including the option to allow props and other maintenance equipment on the boat. All equipment including water must come back complete.

Long-haul:

Toolkit - flip kit with a minimum of: (all to be kept in a dry sealed container).

1. Easy start spray (or similar product)
2. Number 7 flexible socket
3. 3 x dry spark plugs
4. Spark plug spanner
5. Phillips screwdriver
6. First Aid kit
7. Paddles x 2 (two) attached to the boat
8. Orange flag min 0.6 x 0.4 m and means of hoisting to indicate retirement
9. VHF radio or mobile phone in waterproof case - fully charged
10. Emergency water 2 x 1lt and 2 x energy bars (glucose or similar), these must come back still sealed and not opened - they are only as an emergency.

Ultra Long-haul: The organizers may require competitors to carry the above plus any of the following:

1. Pencil flares x 6 (in date)
2. 1 m x 3 m ID sheet for boats whose pontoons are not red, yellow or orange in colour
3. Anchor 1.5 kg with chain 2 m (min 4 mm thick)
4. Anchor rope x 30 m
5. A drogue anchor
6. Space blankets x 2
7. 1000ft flares x 2 (in date).

170.041.5 BEACH STOPS

1. Not doing the required number of beach stops will result in disqualification.
2. Boats are to beach as per the OOD instructions at Drivers Briefing 'High-speed' drops are not allowed onto the beach; a 2-point penalty can be given by the O.O.D.
3. At all beach stops the motor must be shut-down and the boat must remain in the waterline, the Co-Driver must not leave the boat until the engine has been killed, and must not be started until such time that the Co-Driver has returned and in the boat. Not shutting-down the engine at beach stops will result in a 2-point penalty time penalty.
4. The Co-Driver must leave and enter via the side of the boat only, entry or exit via the stern or bow of the boat will result in a 2-point penalty.
5. A single back-up crew may assist with handing the spare fuel tank to the driver and taking away the empty tank but they must not assist with connecting or assisting with the boat / engine in any other way. The O.O.D may allow further assistance with holding the boat in rough/ windy conditions, this will be agreed at Drivers Briefing.
6. No interference by any competitor or his back-up crew with another competitor on a beach stop is allowed. Any obstruction of any kind will be penalised with a disqualification from the race.

DIAGRAM G: Guide to Surf Course Layout

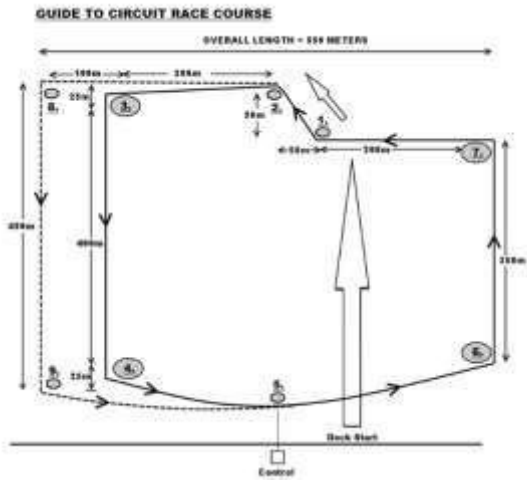

DIAGRAM H: Guide to Circuit Course Layout

